

# A guide for riders

Welcome to Cowboy.  
Your new bike has arrived with  
a new way to move in the city.  
As you map your own path we'll  
be there to power you forward,  
open to the road ahead.





Cowboy S.A.  
67 Rue de la Régence  
1000 Brussels, Belgium  
cowboy.com





## **Find your language**

This guide is available online  
in Danish, Dutch, English, French,  
German, Italian, Spanish and Swedish

[cowboy.com/pages/downloads](http://cowboy.com/pages/downloads)





# Contents

This guide will get your new bike set up and ready to ride

---

## Get Ready

8  
9–23  
24–29

What's in the box  
The set-up  
Know your bike

---

## Connect

30–33

The app

---

## Ride

34–35  
36–37  
38–39  
40–41  
42–43

Accessories  
Before you ride  
Battery care  
Bike maintenance  
Built for any season

The product you have might differ from what is reflected in the images in this manual

# 00

## What's in the box

---

**Battery keys x2**

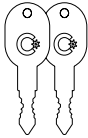

**Battery charger**

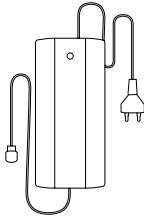

**Pedals x2**

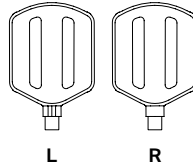

**Belt spanner x1**

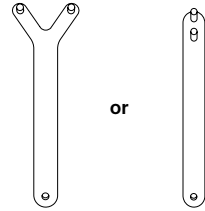

**Allen key 3**



**Butterfly Allen key 4**



**Allen key 5**



**Allen key 6**



## The set-up

All the Cowboy essentials are in your hands. Follow the instructions, and in just a few steps you'll have your bike put together.

---

### Classic

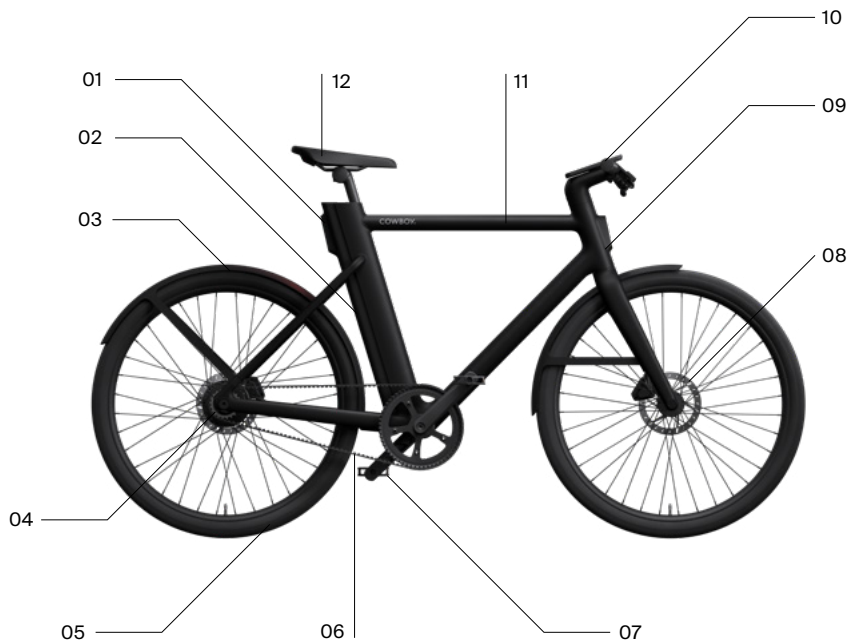

## The essentials

01 Rear light

02 Removable battery

03 Mudguards

04 Rear hub motor

05 Puncture-resistant tyres

06 Carbon belt drive\*

### Cruiser ST

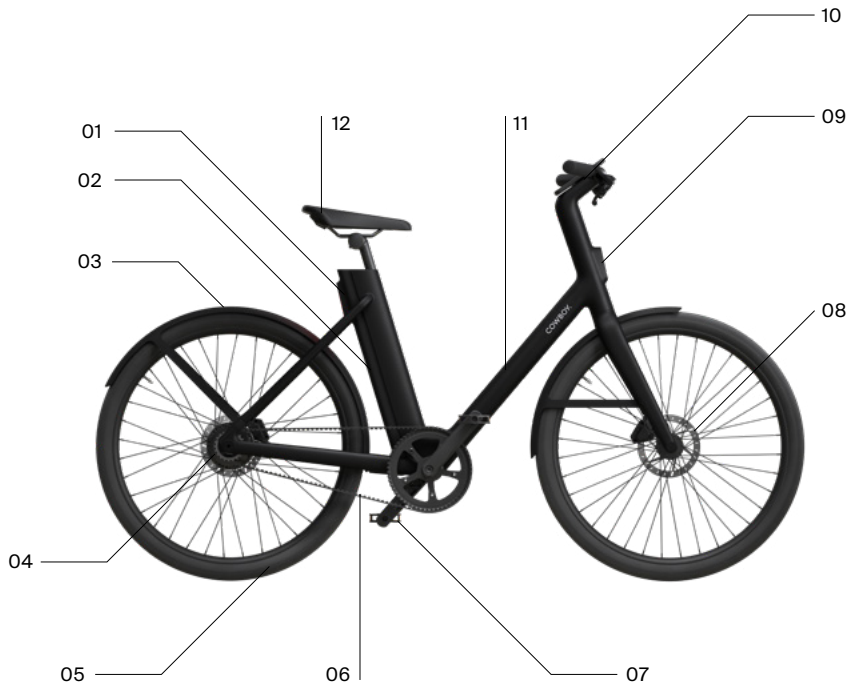

07 Pedals  
08 Hydraulic disc brakes

09 Front light  
10 Cockpit

11 Frame  
12 Adjustable saddle

## Cruiser

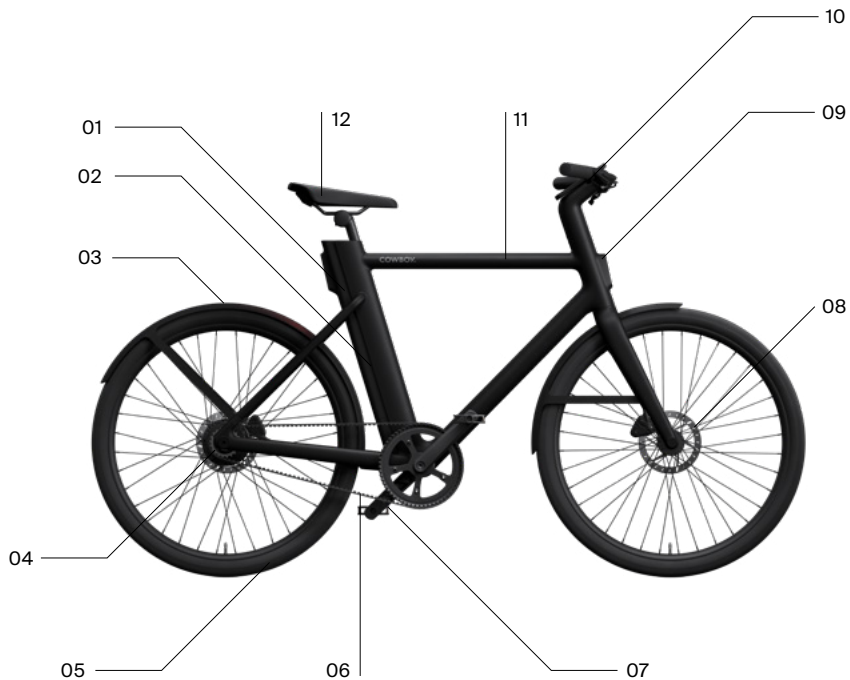

# 01

## Handlebar

### 01 Check

Your bike comes with the handlebar parallel to the wheels and frame.

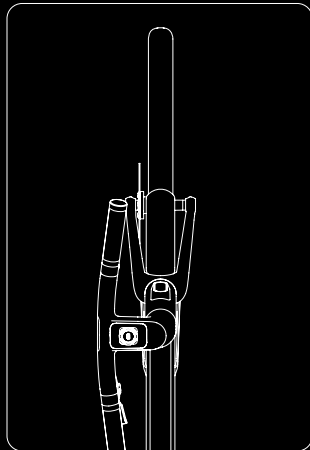

### 02 Rotate

Turn the handlebar 90° clockwise until it's at a right angle to the rest of the bike. It's important that the front brake disc marked in the diagram ends up on the left side of the wheel.

If you see the disc brake is sitting incorrectly on the right-hand side, turn the fork in the anticlockwise direction to rectify.

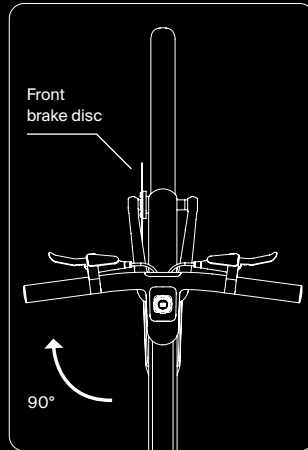

### 03 Secure

Use Allen key 3 to tighten the two screws securely as shown. This will keep your handlebar in place. Be sure to use the short end of the Allen key for the most tightening force, then test it to make sure it's fully secure by blocking the front wheel between your legs and trying to move the handlebar from left to right.

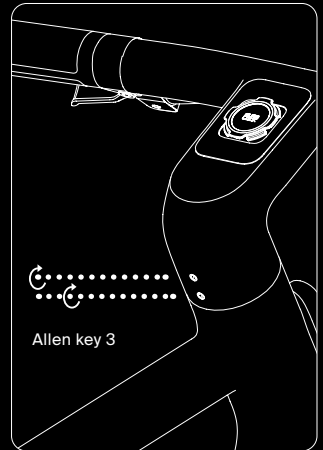





9:41

200m

Rue de l'Arbre

Rue de l'Arbre

Stationnement Gratuit

25  
km/h

15 minutes  
2.3 km · 9:56

60  
km/h

Exit

# 02

## Brakes

### 01 Loosen

When you ride, the brake levers should be fixed on the handlebar at a 45° angle from the ground. Check the position of your brake levers. If they are already at a 45° angle, they do not need adjusting. If the brake levers are pointed down towards the ground as in the illustration below, then first loosen the screw under each brake using Allen key 5 as shown.

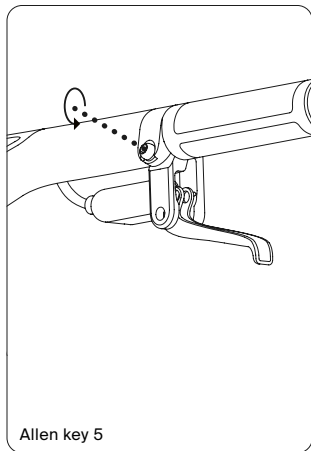

### 02 Turn up

Turn the brake handles and grips up until the brake handles are at a 45° angle. Hold them in place. Just as you can set your brake handle position, you can also rotate the grip position to be more comfortable.

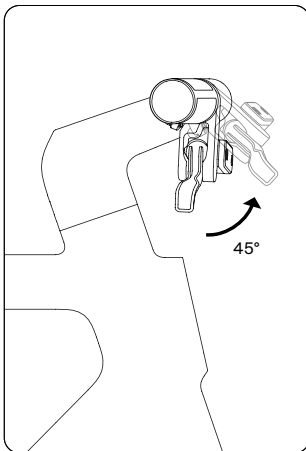

### 03 Tighten

Tighten the screw as shown using Allen key 5. Make sure it's nice and tight so that the brake levers don't rotate, taking care to not overtighten. For brake maintenance see page 40.

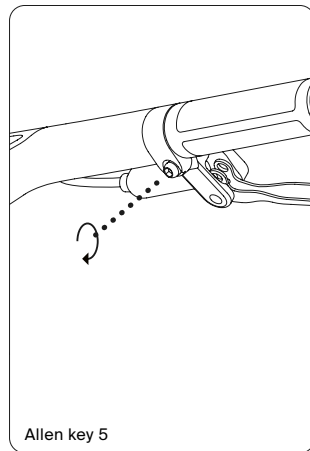



# 03

## Pedals

### 01 Know right from left

The right and left pedals are different. You can tell them apart by their position in the box and the three small grooves on the left pedal axle only. You will also find the stamped 'R' and 'L' on the end of the axle.

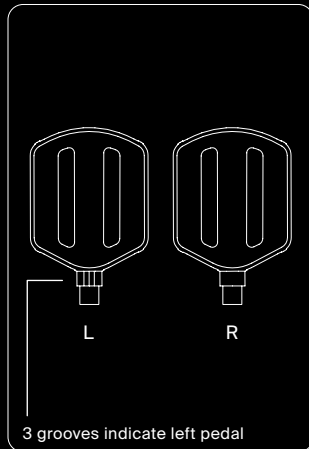

### 02 Screw in

Take the right pedal and screw it in clockwise as far as you can by hand. It should screw in easily. If it doesn't, stop right away as you may be crossthreading the screw. Make sure the pedal is properly aligned before trying again.

Repeat these steps for the left pedal, screwing anticlockwise this time.

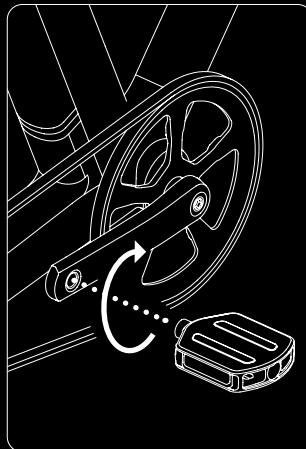

### 03 Tighten up

Insert the shorter end of Allen key 6 into the screw head on the side of the pedal closest to the frame. Tighten firmly.

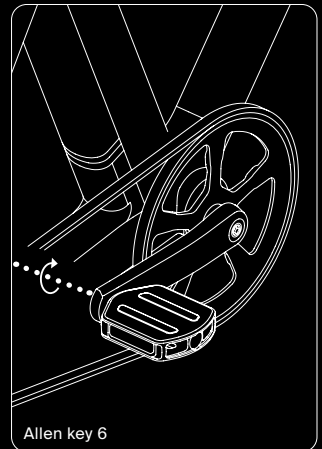



# 04

## Saddle

### 01 Find the right position

Let's work out your perfect saddle height. Sit on the bike and move the pedal around with your foot until it's closest to the ground in the 6°clock position. You'll know the saddle is the right height when your leg is just slightly bent as shown.

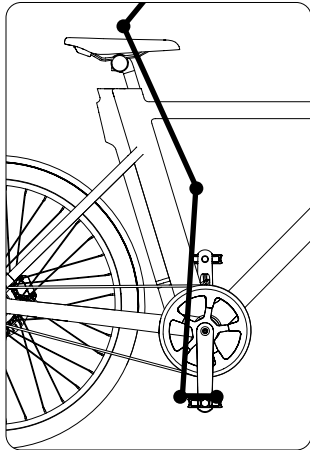

### 02 Take out the battery

To change the saddle height, you'll first need to take out the battery using one of the battery keys provided.

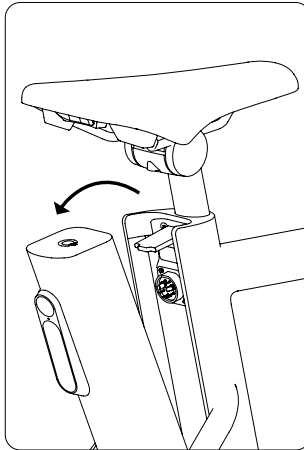

### 03 Adjust the height

Loosen the saddle by turning the Butterfly Allen key 4 in the two holes as shown. Then raise or lower the saddle to where you want it, being careful not to raise it higher than the depth warning mark indicated on the saddle post. Use the Butterfly Allen key again to secure it in place.

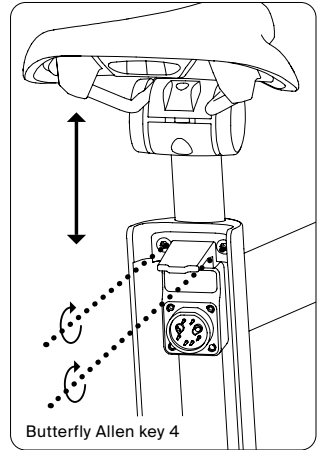



# 05

## Cockpit

### 01 Dock your phone

Put a Quad Lock case on your phone. You can buy one suitable for your phone separately in the Cowboy webshop. Position your phone at 45° and slot the phone over the mount, making sure the two are aligned. Rotate the phone so it's upright at 0° as shown. It should click right into place. Always check that your phone has clicked securely before you ride.

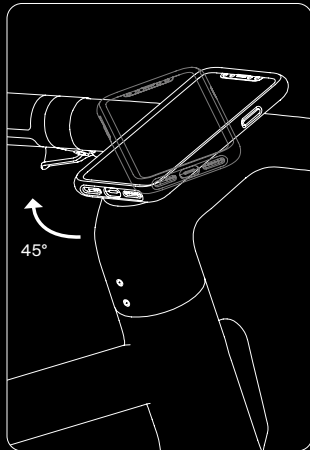

### 02 Charge up

The Performance model comes with wireless charging. If your phone is compatible, it will charge automatically when docked with the bike turned on.

Important note: Don't keep anything metal such as coins and credit cards between your phone and the charger. Don't attempt to mount anything heavier than a smartphone. Consult a physician before using if you have an electrical device (e.g. pacemaker).

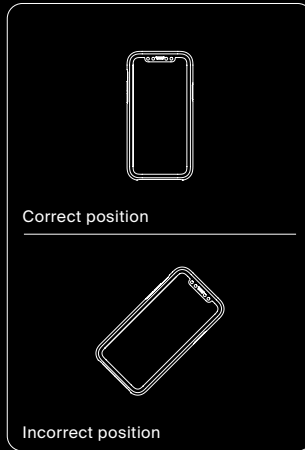

### 03 Undock your phone

To undock your phone, simply turn it back to 45° and you can take it off the mount. Be careful not to leave your phone unattended on the bike as anyone can detach and take it.

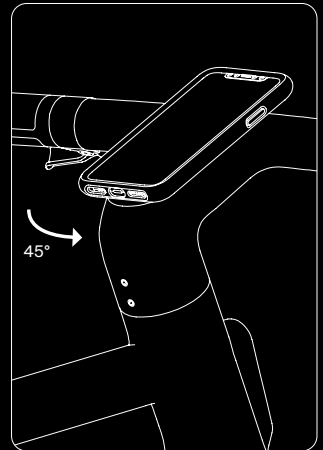









# 06

## Know your bike

### Safety lights

The integrated rear light flashes when you brake to let those behind you know you're slowing down.

### A handy battery

Your battery removes easily and gives you a 40-80km range depending on your riding conditions. If you have the 4A charger, recharge to 100% in 2hrs 40mins. With the 3A charger, it's just under 3.5hrs. When the charger light goes from red to green it's fully charged.

### Motor

250W of electric motor power to assist you up to 25km/h. No gears to bother with, just one smooth ride.

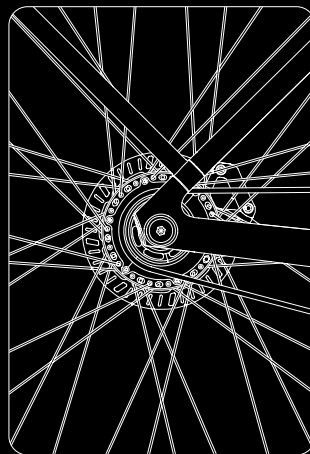
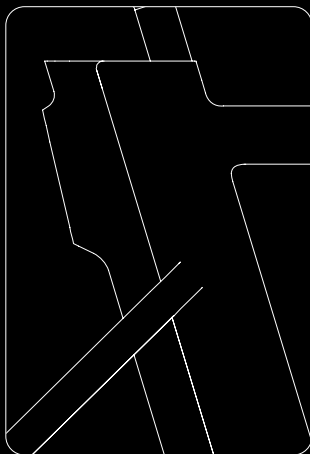
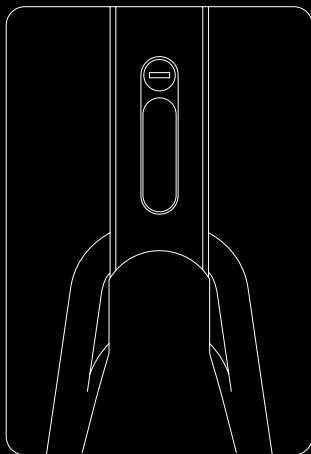

## Communication module

With sensors embedded in the bike, there's constant dialogue with the app and you for an informed, safe and worry-free ride.

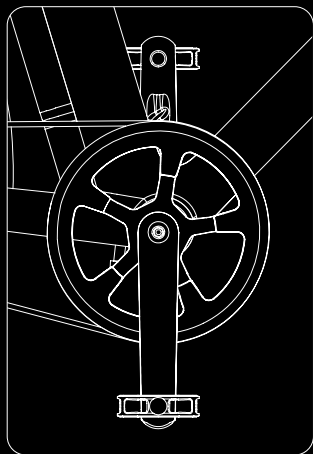

## Brakes

Hydraulic disc brakes offer total stopping power the second you make contact.

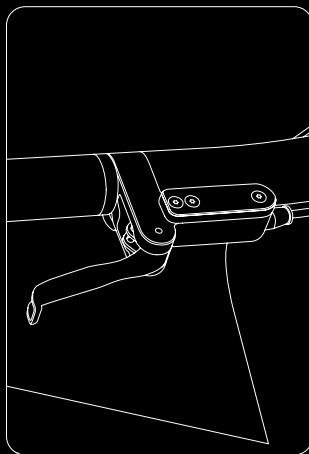

## Tyres

47mm custom tyres with a flexible grip and a puncture protection layer.

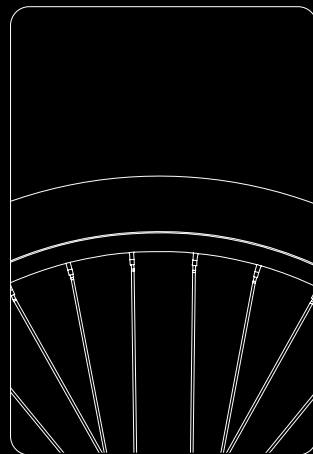

## Know your bike

Now that your bike's assembled, let's take a look at some of the quintessential Cowboy features. From stem to sprocket, every detail is crafted to offer an unparalleled riding experience.

### 01 Rear light

Integrated rear light that flashes when you hit the brakes

### 02 Removable battery

Your battery removes easily and gives you a 40-80km range depending on your riding conditions.

### 03 Motor

250W of electric motor power to assist you up to 25km/h. No gears to bother with, just one smooth ride.

### 04 Gates carbon belt\*

Hassle-free maintenance and no oily chain to mess with





**08 LED display\***

Eight LEDs in the cockpit display your bike's battery level

**07 Front light**

Iconic Cowboy lights mean you're always visible to others on the road

**06 Tyres**

All-rounder tyres with a flexible grip and a puncture-resistant layer

**05 Sensors**

Sensors in the bike frame communicate with the motor and the app

## The connected ride

From mapping the best routes to keeping you informed of the essentials powering your bike, the app is your key to a smarter, more mindful ride.







# 07

## The App

### Road Companion

The Cowboy app is your daily companion on the road. It's always looking ahead, keeping an eye on things like weather conditions while having a little fun along the way.

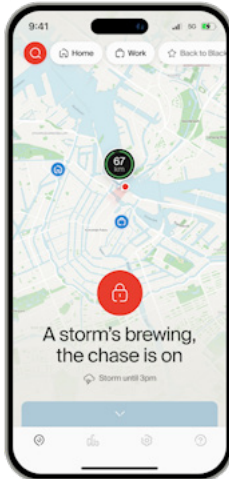

### Ride Dashboard

Monitor your speed, power and battery level at a glance while seeing your ride progress along the way.

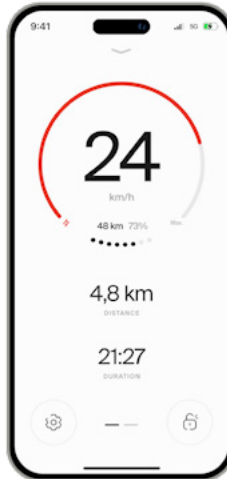

### Navigation

Beat the traffic by mapping the quick route or find the clear way there with Google Maps navigation. As your go-to for bike-friendly directions, you'll be notified when you approach your next turn.

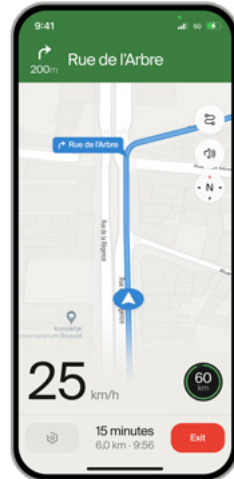

## Pair the app

- 01 Download the iPhone or Android Cowboy app
- 02 Create your Cowboy account
- 03 Turn on your bike and ride
- 04 Keep your app updated for the latest features

## Ride Stats

Check your most recent ride stats and track your activities over time, such as riding streaks, average speed, and moving time. Even earn badges as you unlock new achievements.

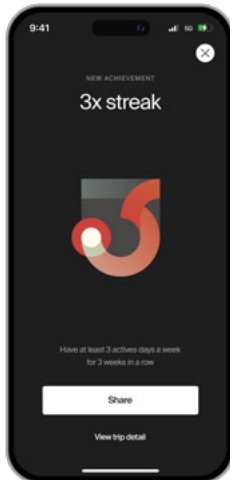

## Find My Bike

With GPS tracking, see the location of your bike anytime and track its live position in the app.

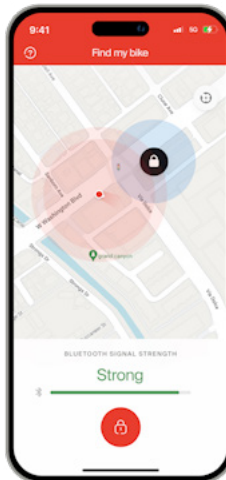

## In-app support

Connect with our support team directly through the app, whenever you need a fix or have any questions on your ride.

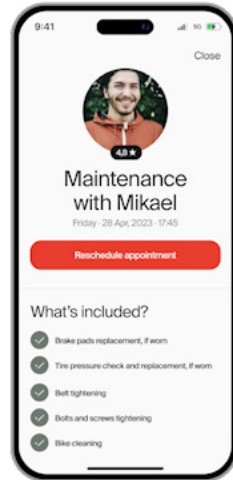

# 08

## Cowboy Connect

### AdaptivePower

The motor adapts instantly to what's around you to give you extra power when you encounter an incline, headwind or added weight. The app will suggest Eco power saving when it's time to conserve.

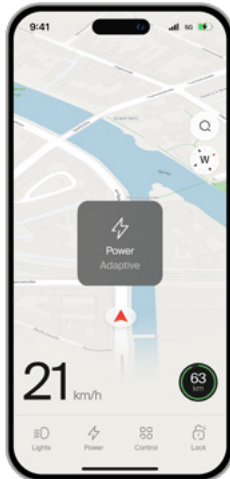

### Predictive Alerts

Your companion predicts what's ahead to ride well informed. With charge reminders and live air quality updates, you'll never leave the house unprepared. With safety alerts, you'll be warned when you approach a dangerous crossroad.

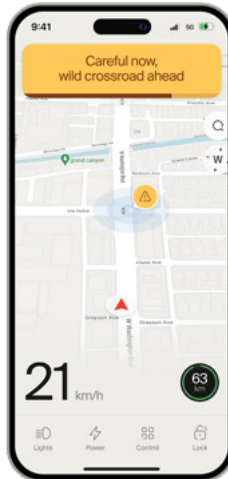

### Crash Detection

Sensors inside the bike detect a fall and signal to the app to alert your emergency contacts.

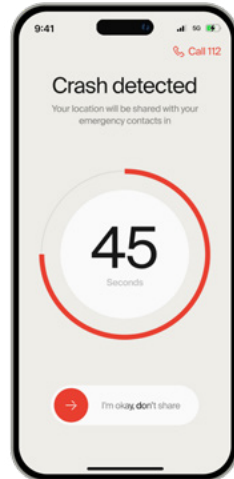

Get to know the latest  
Cowboy technology

- Included in Performance and  
Connect models.

## Ride Analysis

Deeper analysis after each ride  
informs you of details like calories  
burned, human-motor power  
output and new personal records.

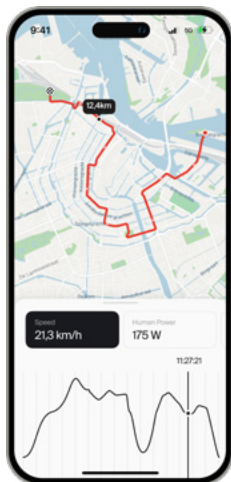

## Share My Ride

Your friends and loved ones can  
follow your ride in realtime. Choose  
to share your ride and you'll see  
their reactions along the way until  
you arrive.



## Health and fitness

With Apple Health and Strava  
integration, automatically sync  
your rides and get credit for all  
your activities. Complement your  
ride with the Apple Watch app and  
see your movements stack up.

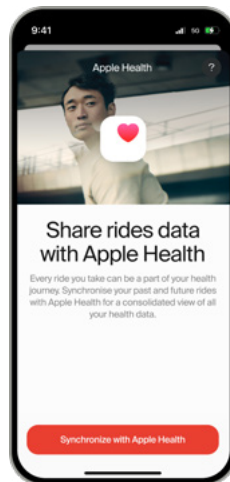

# 09

## Accessories

### Rear rack

Do not use the rear rack as a passenger seat or child carrier. Mount a child seat instead. Be mindful that a loaded rack affects the bike's weight distribution and stability. Stay visible and don't mount accessories that block the rear light. The rack is not designed to tow a trailer and should not be attempted.

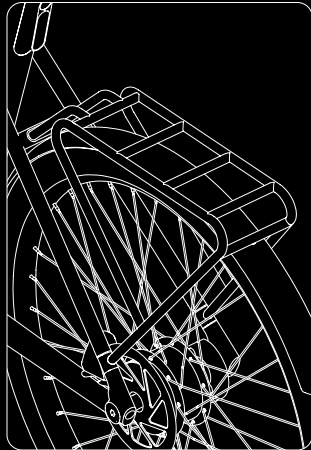

### Kickstand

Simply use your foot to extend the kickstand when you want your bike to stand upright. Be careful of slippage when standing the bike on a wet surface.

The product you have might differ from what is reflected in the images in this manual.

If you ordered any of the custom Cowboy accessories, please follow these tips.

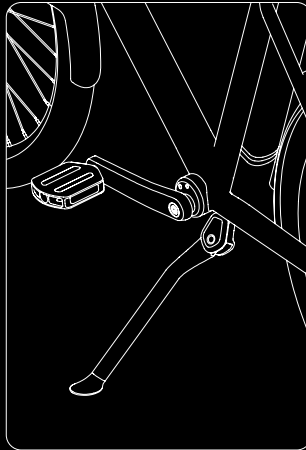



# 10

## Before you ride

---

### Before every ride

1. Make sure that the **battery** is fully clicked into the frame.
2. **Tyres** deflate during shipping and storage. Inflate them to a pressure of 2.5 bars for heavier payload and less for a lighter payload. We don't recommend a tyre pressure below 1.5 bars or at the max pressure of 4 bars as this will make your ride less comfortable.
3. Squeeze the **brakes** to check they are working perfectly.
4. For Performance models with a belt drive, check the belt tension by pressing firmly down in the middle of the belt with your index finger. The deflection of the belt should be between 0.5cm and 1cm.

Note that lubrication is not necessary. Refer to Gates™ carbon drive manual for more

info: [gatescarbondrive.com/resources/manuals-and-tech](https://gatescarbondrive.com/resources/manuals-and-tech)

5. For Core models with a chain drive, check the chain is taut by pressing firmly down in the middle of the chain with your index finger. The deflection of the chain should be between 0.5cm and 1 cm.

Note that lubrication is necessary for any chain drive. See page 41 for instructions.

6. Wear the correct **protective gear**. Always wear a helmet and be visible on the roads.
7. Remember that you will need to brake sooner and more smoothly in **wet conditions** as stopping distances increase.
8. Adjust your **total payload** to stay within the 140kg limits of your bike (including accessories, rider and the cargo).

### Before your first ride

#### Charge up

Fully charge your bike battery before your first ride. When docking your phone in the cockpit, always use the Quad Lock mount provided and check the phone is securely clicked in place. Note that wireless charging (Performance model feature) will not work if you have a metal phone case. Your bike can interrupt wireless charging if it senses your phone is overheating.

#### Take it slow

Get used to your new bike in a safe area with minimal traffic.

When mounting your bike, make sure to not step on the pedals before you sit on the saddle and get a firm grip on the handlebar and brake levers. It is recommended to start with one pedal in the lowest position.

To maximise braking power and avoid squeaking noises you will need to bed in the brakes.

You can do so by coming to a full stop 30-40 times on your new bike.



---

### **Follow local regulations**

If you want to use your bike on public roads, make sure that you comply with local driving regulations, for example those governing lights and reflectors. These vary from country to country.

The regulations on bikes with pedal assistance can change in your country. Make sure you always stay up to date by reading the daily press and government publications.

### **Ride safely**

The bike is equipped with hydraulic disc brakes. Note that the left-hand lever actuates the front brake while the right-hand lever actuates the rear brake. In the UK, it is on the opposite side (rear brake on left-hand side and front brake on the right-hand side).

The brakes on your bike are responsive and you should avoid braking too suddenly. Remember to apply the brakes carefully until you reach a full stop in a safe area.

After heavy use, the brake discs may be hot. Please beware. Stopping distances for your bike may be longer than they are for conventional bikes you may have had experience with. Under wet conditions, stopping distances may increase further as braking effect is reduced. Extra caution is required.

### **Watchouts**

The weight distribution on this bike differs from conventional bikes you may have had experience with. Bear this in mind when loading, parking or lifting the bike.

Do not hang bags or heavy objects on the handlebar as this can have an adverse effect on your ability to accurately and safely steer the bicycle. Note that your bike has been designed for a maximum load of 140kg (bike, accessories, rider and cargo included).

Avoid wearing loose clothes such as skirts and wide-legged trousers and make sure you secure any loose straps. These can get caught in the wheels and cause accidents. You may wish to use trouser grips.

### **Any questions? Speak to us.**

If you wish to attach a bicycle trailer, check the Cowboy webshop to get a specific adapter.

If you wish to use third party accessories with your bike (such as a child seat or a luggage carrier), first check compatibility with the accessory's manufacturer.

# 11

## Battery care

### Range

Your battery will give you an estimated range of 40-80km. However, note that this is an indicative range and the exact range always depends on the riding conditions. A range of 80km or more is typically achievable with a new battery, minimal wind, a consistent speed on a good asphalt road, a load of 75kg and an outside temperature of 20°C.

**The following factors can impact autonomy:**

### Your environment

**Temperature** – Colder surroundings make your battery drain faster. During the winter it's best to store your battery inside to maximise its performance.

**Terrain** – Your range will be lower if you take steep hills than if you stay on flat roads. Poor quality roads, gravel and uneven forest paths also drain the battery faster than good tarmac.

**Wind** – The stronger the wind, the shorter the range.

### Your bike set-up

**Ride mode** – If you own a Cowboy Classic, Cruiser or Cruiser ST with AdaptivePower, you can change your motor assistance level in your ride settings. You'll consume around 25% less battery when switching from Adaptive to Eco.

**Weight** – The more load your bike has to carry the faster your battery will drain.

**Age** – Batteries slowly lose capacity over time, so your range is expected to slowly decrease as the bike ages.

**Tyres** – An under-inflated tyre will have a higher contact surface with the ground, leading to more drag and less range.

**Storage** – Avoid leaving your battery on zero charge for prolonged periods. This will negatively and permanently affect the battery capacity.

### You the rider

**Riding style** – Cruising at a constant speed consumes less power than frequently accelerating and decelerating.

### Protect your source of power

Your battery self-learns in order to improve the accuracy of its estimations any time you discharge the battery when the power level is low (7% power remaining ) and you charge it fully afterward. It's normal for the battery percentage displayed in the app to be inaccurate for your first few rides. The LEDs on the cockpit of the Performance models offer an extra way of gauging your battery level. When the last LED is blinking, it's definitely time to recharge.

Charge the battery indoors between 10°C and 25°C on a non-flammable surface using the charger from the accessories box.

Do not expose the battery or charger to full sun, moisture, or water during charging. Keep the battery away from fire and heat. We recommend charging the battery during the day and in dry rooms fitted with smoke detectors. Do not ride in the rain without the battery inserted to keep the battery connectors clean and dry.

Make sure that the battery is in sound condition with no corrosion, cracking or other damage before using it or charging it. Do not open, disassemble or crush the battery. Do not use a battery or charger that is defective.

Keep the battery and charger out of reach of children.

## Long live your battery

Battery life in general is described as the number of cycles it takes to arrive at 60% of the original battery capacity in ideal conditions. For Cowboy this would be 500 cycles. Note that lithium ion batteries such as yours have

no memory effect. Therefore you can charge your battery after every ride.

### To maximise the lifetime of your battery:

- Avoid leaving it fully discharged for prolonged periods.
- If you plan to not use your bike for longer periods of time, remove the battery from the bike, store it in a dry environment at room temperature (between 10°C and 25°C) and charge your battery every 6–8 weeks. This is to prevent the battery from going into 'deep discharge' mode, which is a necessary battery safety precaution. Once this mode is activated, the battery will need to be replaced, which is not covered under warranty and will incur additional costs.
- The battery pack should be stored at room temperature. Avoid exposing the battery pack to direct sunlight on warm summer days.

- Make sure that the battery gets a full discharge-to-charge cycle at least once every two months.

**Caution:** Inserting anything other than a genuine Cowboy battery presents a serious safety hazard. New batteries can be ordered with us directly. Dispose of used batteries at your local recycling centre. The battery pack must not be stored below -20°C or above +60°C and we recommend it be stored at room temperature. Never place the battery pack near sources of direct heat such as heaters or ovens. Be careful not to drop the battery pack and do not attempt to open it. If you have any doubts, contact customer service for more information.

# 12

## Bike maintenance

### Servicing & parts

We recommend servicing the bike once a year or every 1000km, whichever comes first.

As with all mechanical products, this bike is subject to wear and fatigue. Different materials and components may react to wear and fatigue in different ways. If the design life of a component has been exceeded, it may suddenly fail, possibly causing injuries to the rider. Any form of crack or change in colouring in highly stressed areas indicates that the end of life of the component has been reached and that it should be replaced.

Do not try to open or reach any part of the electrical system of the bike. There is a risk of injury and permanent damage to the bike.

Always use approved Cowboy spare parts should you need any. Contact us via the chat online or in the app, or email us at [hello@cowboy.com](mailto:hello@cowboy.com).

### Cleaning

Always take out the battery before performing any maintenance or cleaning.

Use a moist piece of cloth for the frame and we suggest water when cleaning the saddle. Bike cleaning products can be used to wipe down the frame. Do not steam clean, high pressure clean, or clean your bike and your battery with a water hose.

### Brake pads

Brake pads are an important part of your bike and ensure that you can always ride safely. It is recommended to check them every 1000km or as soon as you feel decreased braking power or hear a creaking noise. Your brake pads have a wear indicator built in. When the surface is worn away so the small blue circle is visible, it's time for a replacement set.

If the brakes of your Cowboy bike look like this:

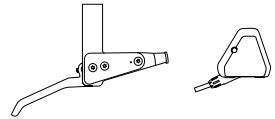

The brake pads you need to use are the Sunrace UWD5 / Tektro F10XS. Other compatible brake pads include:

- Tektro F10BS
- Shimano K03S

If the brakes of your Cowboy bike look like this:

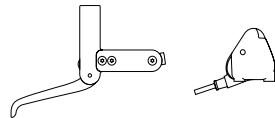

The brake pads you need to use are the Shimano B05S.

The brake system is hydraulic and can only be used with mineral oil. Should the system oil need to be topped up or replaced, use mineral oil.

---

## Tyres

Your tyres naturally wear over time and need replacing. There is a yellow Kevlar compound layer wear indicator inside. When the tyre is worn and the inner layer becomes visible, it's time for a new one. If you need to replace the inner tubes, choose any tube with a Presta valve (aka F/V) compatible with the following tyre dimensions (several ways to define tyre sizes):

- 42-584 / 47-584
- 27,5"x1,65" / 27,5"x1,75"  
- 650-42 / 650-48

If you can't find tubes to fit those dimensions, you may use smaller ones such as:

- 559-47 or 26"x1,75

If you need to remove the wheels for any reason, reassemble the front wheel through the axle with 10Nm torque and the rear wheel nuts with 35Nm. For guidance speak with us in the app or check our online tutorials.

## Belt drive

For Performance models, the carbon belt drive system does not require lubrication. Applying lubricant can cause the system to malfunction.

Regularly inspect the belt and sprockets carefully for signs of deterioration. Make sure the belt is always kept free of any debris and clean it with water and a small amount of soap if need be. Dirt and dust hasten wear, which may cause the belt to break unexpectedly.

When the belt is worn it will need replacing. You can contact us via the chat in the app or online to source a new one.

## Chain drive

For Core models, the chain drive system requires regular lubrication to keep it running smoothly. It is suggested to lubricate the chain every 250km ridden.

Using only chain lubricant, apply it to the inside of the chain

links while turning the crank arms backward. Once finished, turn the crank arm a couple more turns backward then wipe away any excess lubricant with a clean cloth.

When the chain is worn it will need replacing. You can contact us via the chat in the app or online to source a new one.

## Motor

For any motor-related issues, please contact us directly rather than trying to fix them yourself.

The motor is an auxiliary motor limited to 250W of power and provides assistance up to 25 km/h, in compliance with EU regulations. Note that motor assistance will not function below -10°C or above +60°C. The motor assistance system's A-weighted emission sound pressure level at the rider's ears is less than 70 dB(A).

# 13

## Built for any season

---

The bike is designed for high performance in all seasons but there are certain things you can do to take care when battling the elements.

- Invest in rain-proof clothing. High-visibility gear is always good to be seen by others on the darkened road.
- Riding in the slush and snow will kick a lot of salty, dirty water onto your bike. Over time this can lead to damage from corrosion. Be sure to wipe it down with a damp cloth after each ride.
- Extreme seasons go harder on the tyres, so routinely check for wear and tear.
- Remember, less grip on icy roads means it takes longer for the bike to come to a stop. Be mindful to apply the brakes sooner and more smoothly than you would normally.
- For optimal performance and battery life, avoid exposing the bike to direct sunlight on warm summer days.

You're all set to ride in any weather. The seasons come and go but we're always by your side.



COWBOY\*

# 14

# Warranty

## Warranty

1. If you are a consumer you have a legal warranty of 2 years for the goods you purchased from Cowboy. This 2-year warranty still applies if the bike is transferred to another owner, and the warranty expires 2 years after the bike was originally (first) purchased.
2. Bikes sold via the Cowboy Circular program come with a 1 year warranty.
3. This warranty covers all original components against defects in workmanship and materials (e.g. in case the products do not correspond with the product description in the user manual or do not correspond with the advertisement of the product).
4. During the first six months of your warranty, you do not have to prove the defect was already present when you bought the product.
5. The warranty does not cover damages or defects due to accidents; an incorrect assembly or installation of the product by the user; an improper or negligent use; operation or transformation of the product; a maintenance contrary to the maintenance instructions of the product (eg. lack of maintenance of the brakes).
6. The warranty does not extend to parts that naturally deteriorate and need to be replaced due to normal use. The anticipated lifetime of these parts is dependent on factors such as the extent of use, maintenance, and overall handling. It is the responsibility of the owner to regularly inspect and adequately maintain their bicycle, and replace parts when they have reached their wear threshold. These parts include but are not limited to; tires, tubes, brake discs, brake pads, cables, belts, sprockets, spokes, bearings, saddle damage.
7. It is the responsibility of the customer to ensure that the battery is charged at the appropriate intervals (6-8 weeks) if not using the bike. Failure to do so may cause the battery to go into deep discharge mode, which is a necessary safety feature and requires a replacement of the battery at cost to the customer.
8. The warranty explicitly excludes coverage for any issues arising from the alteration or transformation of the product, including the use of third-party applications to modify or adjust motor controller settings. It is important to note that even a single modification can directly result in damages. Moreover, if such alterations lead to issues with other aspects of the bike, including its hardware, those specific issues will also not be covered under this warranty.
9. Claims under the warranty must be made directly to Cowboy. Any repair under warranty needs to be executed by Cowboy or approved by Cowboy in advance. If not, Cowboy has the right to refuse the warranty claim.
10. If a warranty claim is accepted, we will, in our sole discretion, provide a replacement (which is not necessarily identical) for any defective part or component(s), or we may make reasonable commercial efforts to fix the part or components. Cowboy will cover the expenses of the part, shipping, and any associated repair labor costs. Any additional transportation costs (such as those incurred if the customer requests an on-site technician to carry out the repair, or travel expenses to and from a service point) will be the responsibility of the customer.
11. Any replacement parts or components will be covered under warranty for the same length of time as the original product, and will expire at the same time as the original product's warranty.



- 
12. The warranty referred to in this article applies to products intended for use within Cowboy shipping countries: Belgium, Netherlands, Germany, France, Luxembourg, Denmark, Sweden, Italy, Spain, Austria, UK, USA. Cowboy has no (warranty) obligations towards the consumer should the product be used outside those countries.

We reserve the right to update and modify these terms and conditions at any time without prior notice. In the event of any conflict between these terms and conditions and any printed version thereof, the most current version of these terms and conditions as published on our website shall take precedence.

## Intended use

You run the risk of an accident if you modify or tune your bike yourself. Modifications made to your bike can void the warranty and may render the bike no longer approved for use on public roads. You should not perform any maintenance work on your bike without experienced knowledge. If you have any doubts or questions, contact us via the app or the chat on the website. Always use Cowboy genuine spare parts should you need any. There is a risk of explosion if the battery is replaced with anything other than a genuine Cowboy battery. New batteries can be ordered with us directly. Dispose of used batteries at your local recycling centre.

---

The product: bicycle with electric pedal assistance.

---

Cowboy bikes are in compliance with directives 2006/42/EU, 2011/65/EU, 2014/53/EU, 2014/30/EU.

---

To see the full EC declaration of conformity, visit <https://cowboy.bike/pages/downloads>

## Community

Join the streets of Cowboy  
for a new perspective in the  
living city.

Share your ride #cowboybike

Follow us @cowboybike

