

KQi1



CONTENTS

Riding Safety	01
Packing List	03
Parts Info	04
Dashboard Info	05
Installation Guide	06
Downloading the App	12
ARE YOU READY	14
Warnings	16
Troubleshooting	22
Maintenance and Care	24
Specifications	28

Riding Safety

Please read this manual carefully to better understand the product before riding. Please read the important safety precautions in this manual carefully and always abide by local laws and regulations when riding.

IMPORTANT! Read carefully and keep for future reference.

- Please read the product manual carefully, and ride carefully before you understand the characteristics of the kick scooter.
- This kick scooter is a transportation and recreational tool. When riding in a public area, this scooter may be treated as a vehicle, and there are potential safety risks with all vehicles. Please use this product according to the instructions and warnings in this Manual to maximize the safety of you and others, and comply with national and local laws and regulations.
- Even if you fully comply with this safe driving guide, you may face risks caused by illegal driving or improper operation from other vehicles and individuals. Like all vehicles, the faster you drive a kick scooter, the longer the distance required to brake, it is recommended to ride in a relatively closed and flat road environment (such as inside a community, park, special closed venue , etc.). Therefore, it is important to be vigilant and maintain the proper speed during driving, as well as to maintain a reasonable safety distance from others and vehicles. Please be aware of your surroundings and ride at low speed when on unfamiliar terrain.
- Please respect the pedestrians' right of way when driving. Avoid scaring pedestrians, especially children. Alert pedestrians when passing behind them and slow down when passing. Pass from the left side of pedestrians if possible (applicable to the country where the vehicle is traveling right). When facing pedestrians, keep to the right and slow down to pass.
- When riding in countries and regions where there is currently no relevant regulations for kick scooters, you must strictly comply with the safety requirements for riders in this Manual. The manufacturer will not bear any direct and joint liability for any property loss, personal injury, accidents or legal disputes caused by the using behavior violating safety tips in this Manual.
- Take the time to learn the basics of the practice to avoid any serious accident that can take place in the first months.

- Do not lend the kick scooter to a person who can't operate, so as to avoid injury. Please make sure that the rider has read this Manual and learned the novice teaching before lending the kick scooter to others, and remind riders to wear a helmet and protectors to ensure their safety.
- Check the basic condition of the kick scooter before each ride. Discontinue use and don't ride forcibly if you find such situations influencing driving safety that parts are loose, the parts are damaged, the battery life significantly decreases, the tires are flat or excessively worn and the scooter has abnormal noises or alarms.
- Please properly keep your product packaging in case you need to return or repair in the future. If you use non-original packaging, you will be responsible for the damage caused during transportation, additional logistics costs and other related expenses .

Packing List

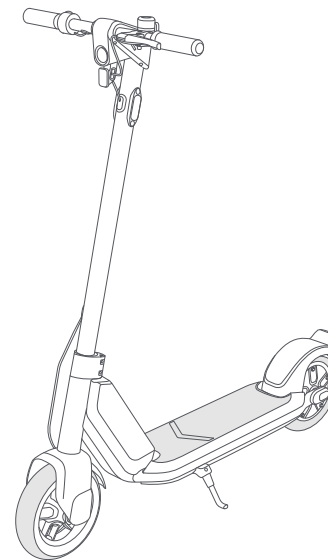

Extension nozzle

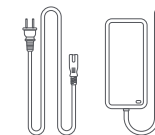

Power adapter

Parts Info

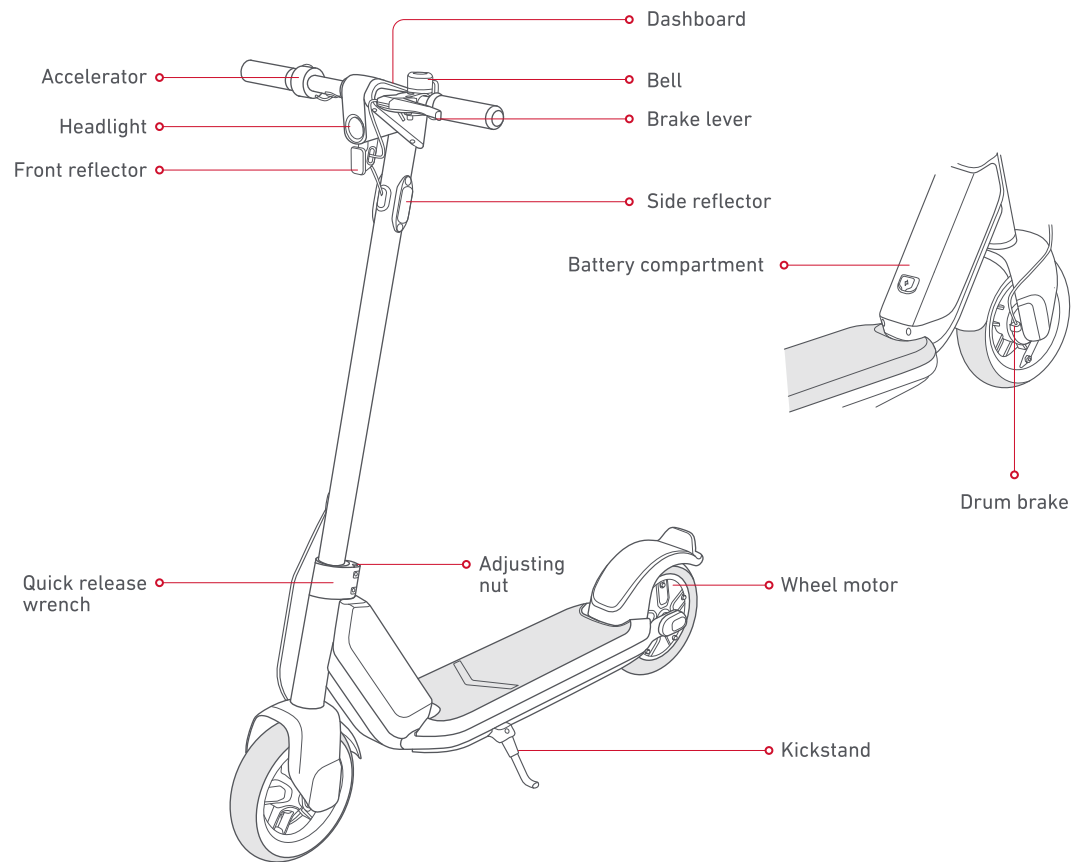

Dashboard Info

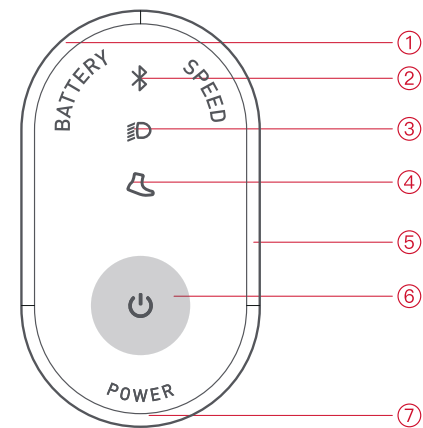

① Battery level indicator

Flashing red: 0%~19%
 Solid orange: 20%~39%
 Solid yellow: 40%~60%
 Solid green: 61%~100%

⑤ Speed indicator

Green: 0 ~ 1/3 of maximum speed
 Orange: 1/3~2/3 of maximum speed
 Red: above 2/3 of maximum speed

② Bluetooth status

③ Headlight status

⑥ Power/mode switch button

Long press to switch on/off the scooter.
 In the power-on state:
 Short press × 1 to switch the riding mode
 Short press × 2 to switch on/off the headlight
 Short press × 3 to enter pedestrian mode

④ Pedestrian mode

Short press × 3 to enter pedestrian mode
 In this mode, the maximum speed limit is 6km/h
 Short press × 1 to exit this mode

⑦ Gear indicator

Light blue: E-Save mode
 Dark blue: Sport mode
 Green: Custom mode (in App)

Installation Guide

Body assembly

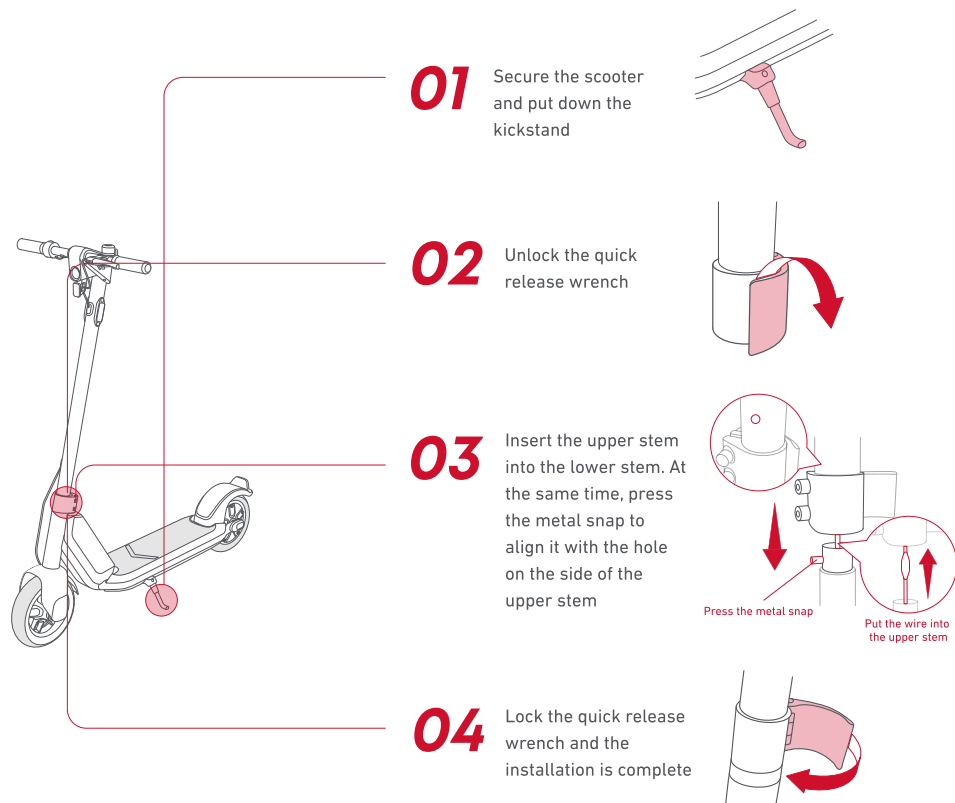

Stem Removal and Installation

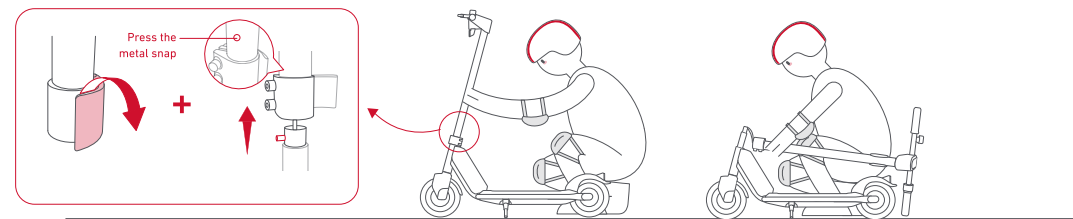

Removal

Make sure the electric scooter is switched off, hold the stem by hand and unlock the quick release wrench. Press the snap to lift the stem up and pull it out.

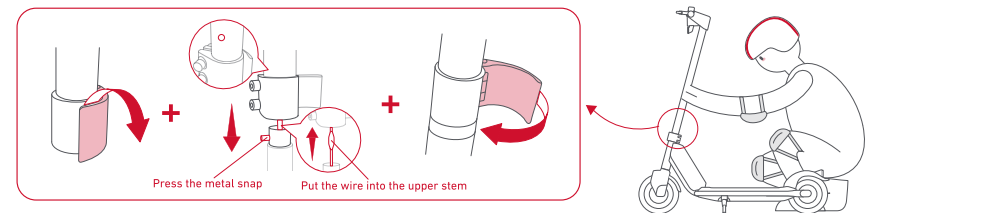

Installation

Secure the scooter and put down the kickstand. Unlock the quick release wrench, and insert the upper stem into the lower stem. At the same time, press the metal snap to align it with the hole on the side of the upper stem. Lock the quick release wrench and the installation is complete.

Adjustment of Brake Cable Length

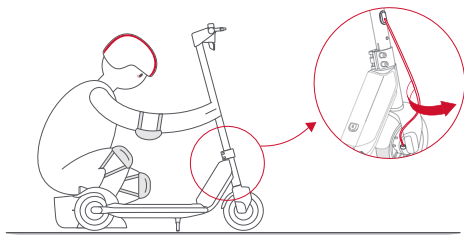

During removal, if the lower brake cable is not of sufficient length, pull down the lower brake cable appropriately.

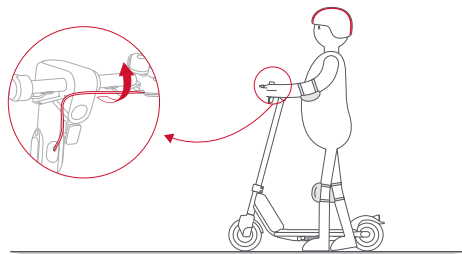

After the installation is complete, if the lower brake cable length is excessive, pull up the upper brake cable appropriately.

Parking

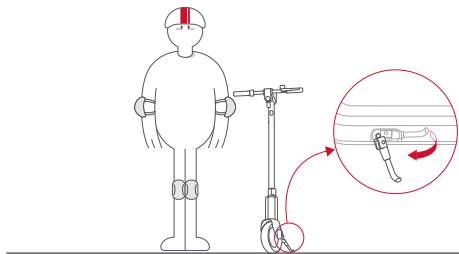

When you finish using the scooter, park it with the parking device. Turn off the parking device before using the scooter.

Charger Connection

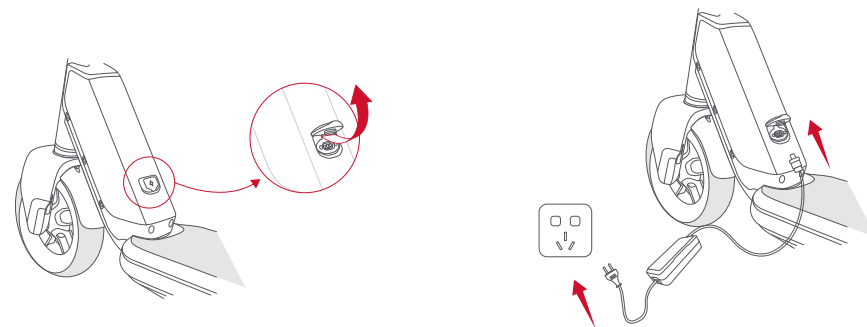

Firstly open the charging port, then plug the charging plug into the body charging port and finally connect the power supply to charge. After the completion of charging, fastening down the charging port to beware of water intake.

⚠ CAUTION

- Do not charge when the charging port, charger or power socket is wet.
- Turn off the power before charging.
- The original charger provided by Niu can be only used when charging. Do not use any other type of chargers.
- Do not charge or continue using the battery if the battery is damaged or flooded.
- Fasten the rubber plug of the charging port before or after charging.
- Do not charge outdoors.
- Do not ride while charging.

Quick locking

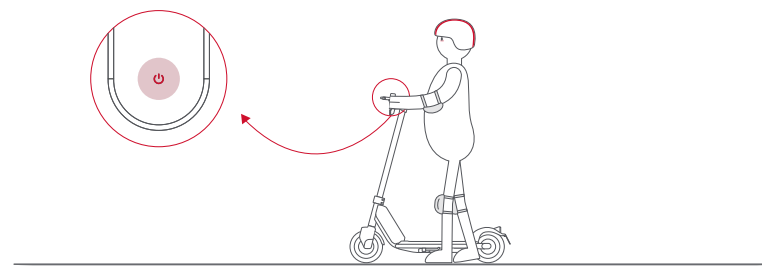
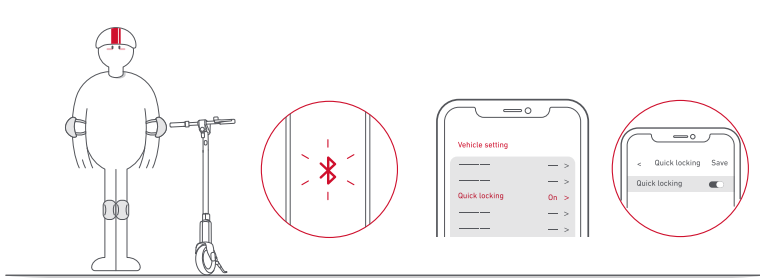

Lock

01

Connect your electric scooter to the installed App of Niu Technologies via Bluetooth, and activate the fast locking function in the App.

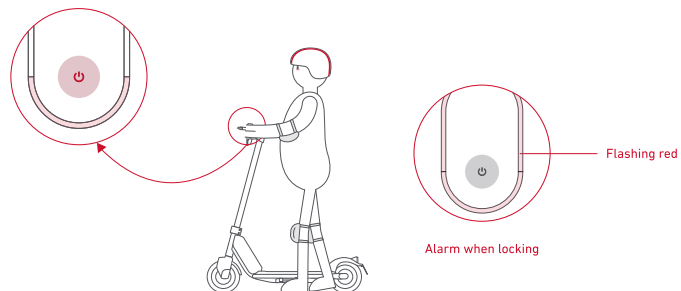

02

Long press for 5 seconds. When the power light is red, the scooter is locked.

Unlocking

01

Long press to switch on the scooter.

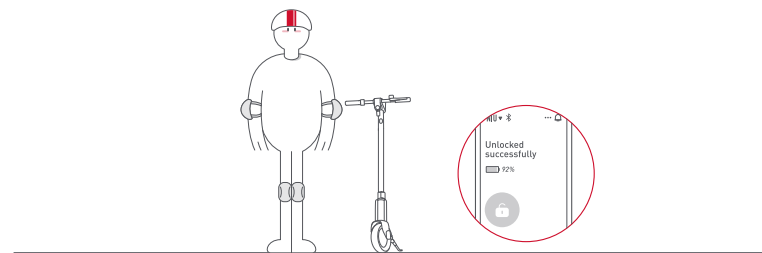

02

Connect the App to the electric scooter, and click the unlock button on the App interface to unlock the scooter.

Downloading the App



NIU E-Scooter App

Scan the QR code on the left, install the Niu E-scooter App, bind and activate the scooter according to the prompts.

Your mobile phone needs to be the Bluetooth functional version 4.2 or above; iOS system version 10.0 or above; Android™ system version Android 5.0 or above.

Bluetooth Operating Frequency: 2402-2480 MHz; Max Radio Power: 2 dBm.

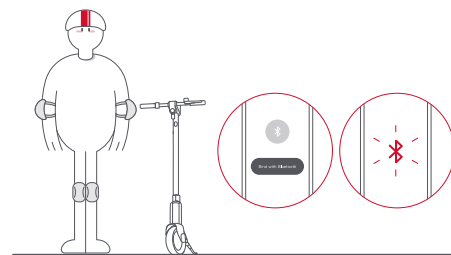

03 Click [Me], [Device Binding] and [Bind with Bluetooth] to connect to your scooter. The scooter beeps, indicating that the Bluetooth is connected successfully. The icon will stop flashing and keep on once the connection is successful.

* The account paired with the Bluetooth for the first time is the vehicle owner. If the vehicle owner changes the mobile connection, the Bluetooth pairing needs to be reset.

* In case of changing the account connection, the original vehicle owner's account needs to be unbound.

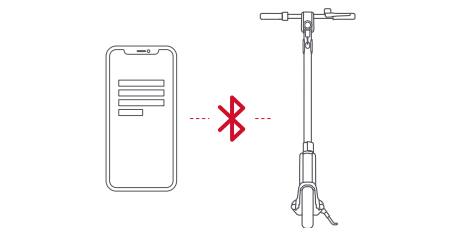

01 After installing the App, please log in and register.

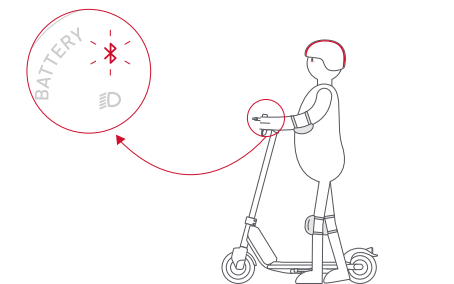

02 Long press the button to power it up and the Bluetooth icon will start flashing.

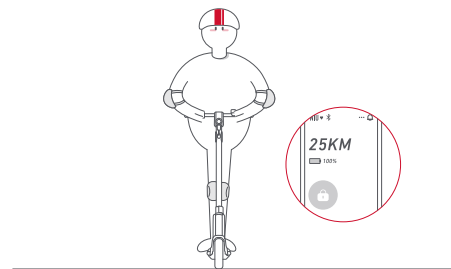

04 Activate the scooter according to the prompts of APP and learn how to drive safely. Now you can get your scooter started, check the status of your scooter and interact with other riders through the APP. Enjoy yourself!

ARE YOU READY?

Like all vehicles, there are potential safety hazards for scooters. Before using it for the first time, you need to check the following.

For your safety, the new scooter will be locked in E-SAVE mode when it is used for the first time. After you finish a 200m ride, the scooter will give off a beeping sound. At this time, you can switch modes and ride at the maximum speed.

Precautions before riding:

- Ensure that the steering system and folding system are working properly, and the components are tightly secured.
- Check whether the wheel axle is fastened to the body to ensure that the wheel can rotate normally and the brake system can work normally.
- Please check the tire pressure before riding. It is recommended that the tire pressure be between 45-50psi.
- Check the wear of the tires and brake pads. If the wear is serious and need to be replaced, please contact the dealer in time.

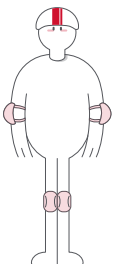

The risk of fall injuries is present during practice, so please wear a helmet and protectors all the way.

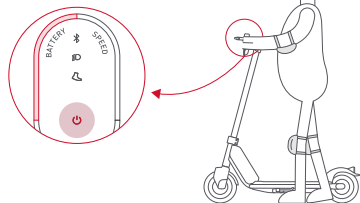

01 Turn on the power and check the power indicator.

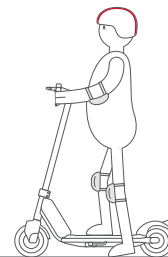

02 Stand on the pedal with one foot and push back with the other foot.

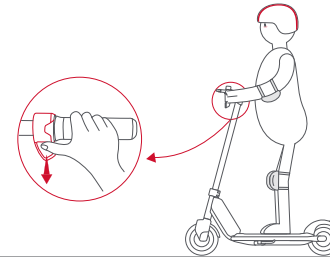

03 When the kick scooter is sliding, stand on the pedal with the other foot, keep both feet stable, while gently pressing the throttle twistgrip. (The speed above 4km/h will start the throttle)

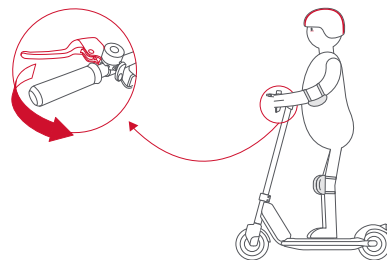

04 Release the throttle twistgrip and use the energy recovery to achieve the effect of deceleration. Emergency braking requires powerful grip on both sides of the brake levers.

* The deceleration can be adjusted through energy recovery within the app.

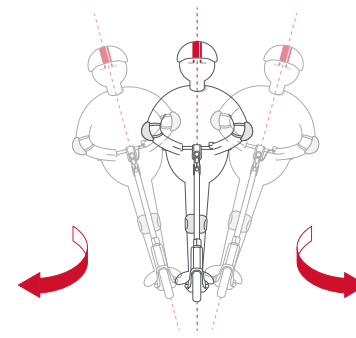

05 The body should lean slightly to the direction of turning, and slowly turn the handlebar during a turn.

Warnings

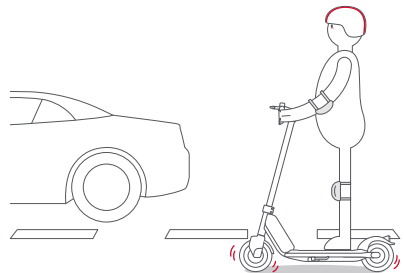

⊗ It is forbidden to drive into public roads, motorways or highways.



⊗ Please avoid riding in the rain. Braking distance will be extended in wet weather, so drive carefully.

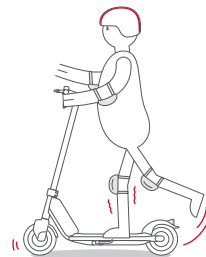

⊗ Do not ride with one foot on the pedal or on the ground. Please always wear shoes.

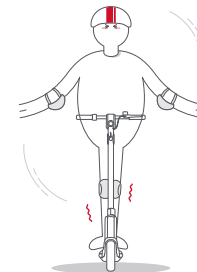

⊗ Always keep your hands on the handlebar when driving.



⊗ It is forbidden to drive if water level exceeds 2cm.

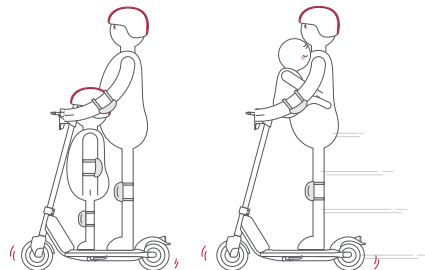

⊗ It is forbidden for multiple people to drive a scooter or to drive with children in arms.

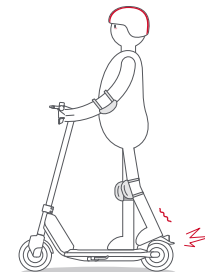

⊗ It is forbidden to step on the back of the mudguard.

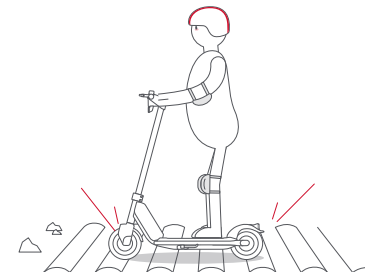

⚠ Do not pass at high speed when encountering deceleration zone / potholes or other unconventional roads pavement.



⊗ Do not accelerate downhill.

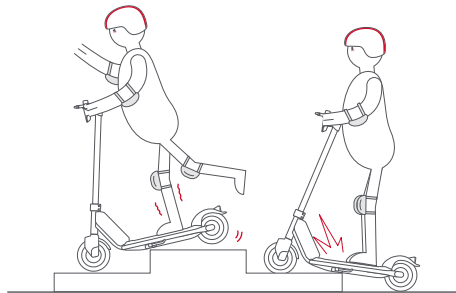

⊗ It is forbidden to ride up and down stairs on kick scooters as well as jumping obstacles.

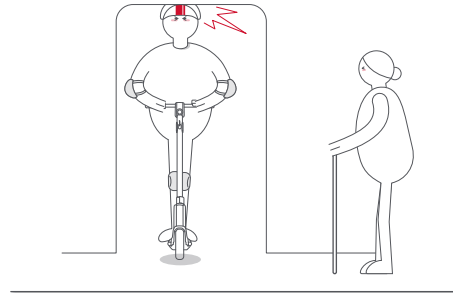

⚠ Do not drive indoors.

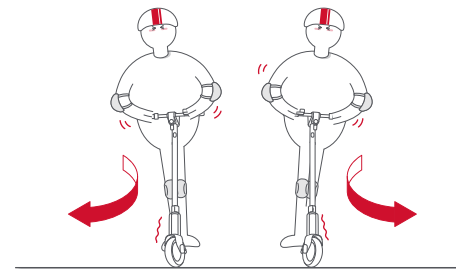

⊗ It is forbidden to turn the handle substantially at high speed.

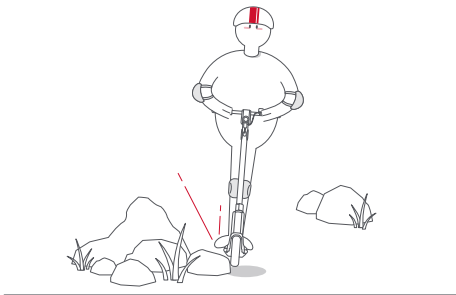

⚠ Please avoid obstacles. Turn on the vehicle headlight when driving in the dark.

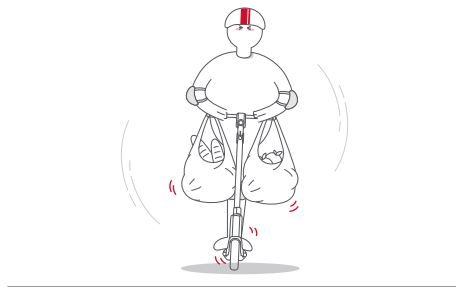

⊗ Do not hang heavy objects such as backpack on the handlebar as the stability of the vehicle can be affected.



⊗ Do not twist the throttle when walking with the kick scooter.

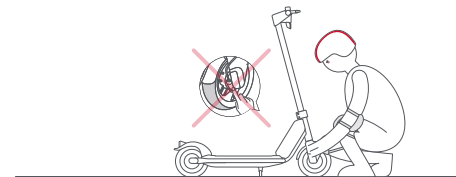

⊗ Do not touch the hot drum brake immediately after use.

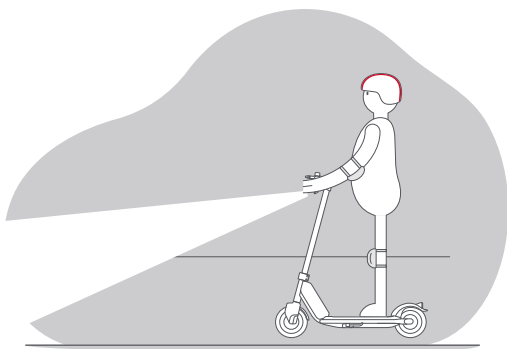

 Advice not to ride in the darkness.

WARNING

- WARNING! As with any mechanical component, a vehicle is subject to high stresses and wear. The various materials and components may react differently to wear or fatigue. If the expected service life for a component has been exceeded, it may break suddenly, therefore risking causing injuries to the user. Cracks, scratches and discoloration in the areas subject to high stresses indicate that the component has exceeded its service life and should be replaced.
- Traffic conditions in the city has many obstacles to cross such as curbs or steps. It is recommended to avoid obstacle jumps. It is important to anticipate and adapt your trajectory and speed to those of a pedestrian before crossing these obstacles. It is also recommended to get out of the vehicle when these obstacles become dangerous due to their shape, height or slippage.
- WARNING! Keep plastic covering away from children to avoid suffocation.

WARNING

- Get closer to your seller so he can refer you to an appropriate training organization.
- Avoid high traffic or overcrowded areas.
- In any case, anticipate your trajectory and your speed while respecting the traffic rules, sidewalks and the most vulnerable, the pedestrians.
- Notify your presence when approaching a pedestrian or cyclist.
- Walk while crossing the protected passages.
- In all cases, take care of yourself and others.
- Do not divert the use of the vehicle.
- This vehicle is not intended for acrobatic use.
- Caution, the brake may become hot in use. Do not touch after use.
- Eliminate any sharp edges caused by use.
- Do not modify or transform the vehicle, including the steering tube and sleeve, stem, folding mechanism and rear brake.
- The self-tightening nuts as well as the other self-tightening fastenings may lose their efficiency so they may need to be retightened.
- Do not make any modifications that are not noted in the instructions.

Troubleshooting

Troubleshooting of the whole vehicle

Buzzer	Causes	Troubleshooting
3 long beeps, 1 short beep	Battery MOS tube damaged	Please contact the dealer
3 long beeps, 2 short beeps	Battery moistened by water	
3 long beeps, 7 short beeps	Battery short-circuit protection warning	
3 long beeps, 3 short beeps	Battery open-circuit or imbalance warning	
3 long beeps, 4 short beeps	Batter low-temperature warning	Place the vehicle at room temperature and reuse it after the temperature is recovered
3 long beeps, 5 short beeps	Batter over-temperature warning	Please make the vehicle still and use it after the internal temperature of the vehicle is normal
3 long beeps, 8 short beeps	Battery charging overcurrent protection warning	Please disconnect the charger
3 long beeps, 9 short beeps	Battery discharging overcurrent protection warning	Please contact the dealer
4 long beeps	Battery over-charging warning	You can ride normally, and it can recover after electricity reduces
4 long beeps, 1 short beep	Battery over-discharging warning	Please charge the vehicle
4 long beeps, 2 short beeps	Battery communication fault and verification failure	Please contact the dealer

Buzzer	Causes	Troubleshooting
1 short beep	Power tube fault of the controller	Please contact the dealer
2 short beeps	Brake fault	Please check the state of brake handle or contact the dealer
3 short beeps	Accelerator fault	Please check the state of accelerator switch or contact the dealer
4 short beeps	Controller overcurrent	Please contact the dealer
5 short beeps	Controller over-temperature	Please make the vehicle still and use it after the internal temperature of the vehicle is normal
6 short beeps	Fault of driving power of the controller	Please contact the dealer
8 short beeps	Undervoltage/overvoltage of the controller	Please charge the vehicle or contact the dealer
7 short beeps	Controller communication fault and verification failure	Please contact the dealer
1 long beep	Motor locked-rotor	
1 long beep, 1 short beep	Motor phase loss	
1 long beep, 2 short beeps	Motor HALL fault	Please make the vehicle still and use it after the internal temperature of the vehicle is normal
1 long beep, 3 short beeps	Motor over-temperature	

Maintenance and Care

Vehicle cleaning

Wipe the main frame with a soft wet cloth. If buildup is formed and is hard to be cleaned, you can apply toothpaste and rub with a toothbrush repeatedly, and then remove residue with a soft wet cloth.

 Do not clean your scooter with alcohol, gasoline, kerosene or other corrosive and volatile solvents. These substances may damage the appearance and internal structure of the vehicle body. Do not spray the scooter with pressure water guns or water pipes. Before cleaning, make sure that the scooter is in shut-down state, non-charging state, and the charging port has been buckled tightly, otherwise damage may be caused to electric parts by water leaking.

Vehicle storage method

- Accessories and any additional items which are not approved by the manufacturer shall not be used.
- Please store the vehicle in a flat, stable, well-ventilated and dry place.
- Prolonged exposure to UV rays, rain and the elements may damage the enclosure materials, store indoors when not in use.
- For a long storage period, keep the battery power between 30%-70% and recharge it every two months to extend the battery life.
- After long-term storage, please fully charge the battery before use and check the tire pressure.
- Do not charge when the charging port or charging cable is wet.
- If any abnormal sound and noise are caused during riding or pushing, do not ride. Carefully check the source of the abnormal sound and noise before riding again.
- Do not use other models or brands of battery packs, otherwise there may be a potential safety risk.
- Please charge the battery with the original charger, otherwise the battery will be damaged or in danger of ignition or explosion.

- Do not touch the battery contacts, and do not open or expose the shell. Avoid short circuit caused by metal objects contacting the battery contact, otherwise battery damage or personal casualty may be caused.
- Do not store the vehicle near a heat source, otherwise it may cause battery failure, overheating, and even fire risk; If the battery is damaged or water enters the battery compartment, it is prohibited to charge or continue using the battery.

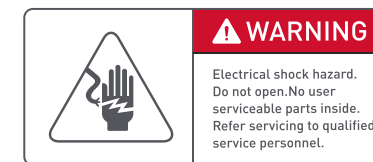

- It is strictly forbidden to immerse the battery and the vehicle body in water or ride in the rain, as well as cleaning the vehicle body with high-pressure water pipes in order to prevent water entering the battery compartment, circuit chip, etc.
- Do not take the battery out. The operation of the vehicle body may be affected due to wrong disassembly.
- Do not hesitate to contact your dealer or send an email to the following mailbox.

Drum brake debugging

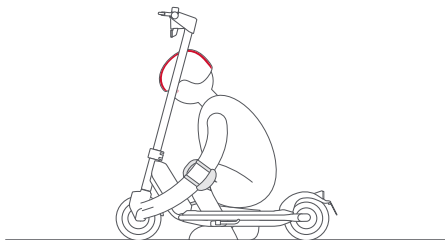

- Excessive braking force

If you feel that the brake is too tight, use a wrench to loosen the brake swing arm nut counterclockwise, return the brake cable to shorten the length of the exposed tail, lock the nut clockwise, confirm the brake force, complete the adjustment.

- Insufficient braking force

If the brake feels too loose, loosen the brake swing arm nut counterclockwise with a wrench, pull out the brake line to make its tail length slightly longer, lock the nut clockwise, and then brake to confirm the brake force, complete the adjustment.

Handlebar shaking debugging

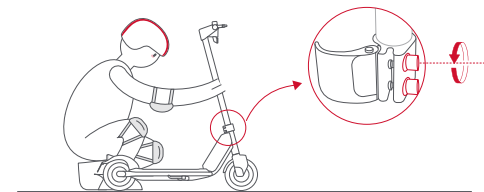

Unlock the folding wrench, turn the two nuts clockwise, and then lock the folding wrench. If the folding wrench feels too tight, turn the nuts counterclockwise properly.

Use of the extension nozzle

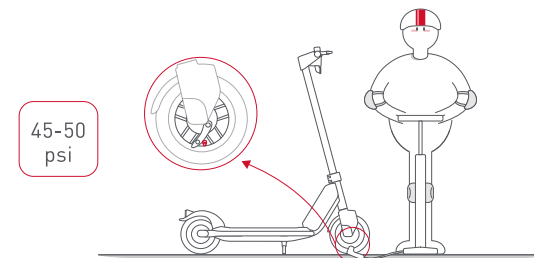

If your kick scooter front and rear tires are underinflated, please use the extension nozzle to connect the car body tires to inflate. First remove the front and rear tire inflatable nozzle cap, and then tighten the extended inflatable nozzle and tire inflatable nozzle, and connect the pump to inflate after they are to be tightened.

Specifications

		KQi1 Sport
Product size	Before folding: Length × width × height	1,102 × 520 × 1,197 mm (43.4 × 20.5 × 47.1 in.)
	After folding: Length × width × height	1,102 × 520 × 490 mm (43.4 × 20.5 × 19.3 in.)
Product weight	Net weight	Approx. 14.6 kg (32.2lbs)
Riding request	Maximum Load	100 kg (220 lbs)
	Age range	14+ years old
	Height	120-200 cm (3'11"~6'6")
Vehicle parameters	Maximum vehicle speed	Approx. 25 km/h (15.5 mph)
	Average battery life ^[1]	Approx. 25 km (15.5 miles)
	Maximum Slope ^[2]	14%
	Applicable terrain	Flat pavement road, steps not higher than 1cm(0.4 in), and road gap not exceeding 3 cm(1.2 in)
	Working temperature	-10~45°C (14~113°F)
	Storage temperature	0~40°C (32~104°F)
	A-weighted emission sound pressure level	50dB
	IP rating	IP54

		KQi1 Sport
Battery pack parameters	Rated voltage	46.8 VDC
	Rated voltage	243 Wh
	Charging voltage	54.6 VDC
	Charging temperature	0~45°C (32~113°F)
	Battery management system	7th NIU Energy™ smart power tech
Motor parameters	Rated power	250 W (0.25kW)
Tire parameters	Tire technical specifications	9" × 2.3"
	Recommended tire pressure	45-50 psi
Charger parameters	Input voltage	100-240 V ~ 1.8 A 50-60 Hz
	Rated output	54.6 V = 1.0 A
	Output power	54.6 W
	Charging time	Approx. 6h

[1] Average battery life: It is tested when the driver weighting 165lbs(75kg) drives at a constant speed of 9.3mph(15km/h) on a flat road in the ambient temperature of 77°F (25°C) in case of a full battery. (Factors affecting battery life include speed, number of startups and shutdowns, kinetic energy recovery setting, driver weight, ambient temperature.)

[2] Maximum Slope: 5m long slope under the condition of full power and maximum load. During the test, there shall be no power failure, stall, etc.