

# KQi2



# CONTENTS

Riding Safety .....	01
Packing list .....	03
Parts Info .....	04
Dashboard Info .....	05
Installation Guide .....	06
Downloading the App .....	12
ARE YOU READY .....	14
Warnings .....	16
Troubleshooting .....	22
Maintenance and Care .....	24
Specifications .....	29

## Riding Safety

Please read this manual carefully to better understand the product before riding. Please read the important safety precautions in this manual carefully and always abide by local laws and regulations when riding.

**IMPORTANT! Read carefully and keep for future reference.**

- Please read the product manual carefully, and ride carefully before you understand the characteristics of the kick scooter.
- This kick scooter is a transportation and recreational tool. When riding in a public area, this scooter may be treated as a vehicle, and there are potential safety risks with all vehicles. Please use this product according to the instructions and warnings in this Manual to maximize the safety of you and others, and comply with national and local laws and regulations.
- Even if you fully comply with this safe driving guide, you may face risks caused by illegal driving or improper operation from other vehicles and individuals. Like all vehicles, the faster you drive a kick scooter, the longer the distance required to brake, it is recommended to ride in a relatively closed and flat road environment (such as inside a community, park, special closed venue , etc.). Therefore, it is important to be vigilant and maintain the proper speed during driving, as well as to maintain a reasonable safety distance from others and vehicles. Please be aware of your surroundings and ride at low speed when on unfamiliar terrain.
- Please respect the pedestrians' right of way when driving. Avoid scaring pedestrians, especially children. Alert pedestrians when passing behind them and slow down when passing. Pass from the left side of pedestrians if possible (Applicable to the country where the vehicle is traveling right). When facing pedestrians, keep to the right and slow down to pass.
- When riding in countries and regions where there is currently no relevant regulations for kick scooters, you must strictly comply with the safety requirements for riders in this Manual. The manufacturer will not bear any direct and joint liability for any property loss, personal injury, accidents or legal disputes caused by the using behavior violating safety tips in this Manual.
- Take the time to learn the basics of the practice to avoid any serious accident that can take place in the first months.

- Do not lend the kick scooter to a person who can't operate ,so as to avoid injury. Please make sure that the rider has read this Manual and learned the novice teaching before lending the kick scootert others, and remind riders to wear a helmet , elbow pads, knee pads and wrist guards while riding.
- Check the basic condition of the kick scooter before each ride. Discontinue use and don't ride forcibly if you find such situations influencing driving safety that parts are loose, the parts are damaged, the battery life significantly decreases, the tires are flat or excessively worn and the scooter has abnormal noises or alarms.
- Please properly keep your product packaging in case you need to return or repair in the future. If you use non-original packaging, you will be responsible for the damage caused during transportation, additional logistics costs and other related expenses .
- User must obey traffic rules of local authorities, and this may change from one place to another.
- This device may be used by children of at least 14 years of age and by persons with reduced physical, sensory or mental capacities or without experience or knowledge, if they are properly supervised or if they have been given instructions relating to the safe use of the device and the risks involved have been understood. Children must not play with the device. Cleaning and user maintenance shall not be made by children without supervision.

## Packing list

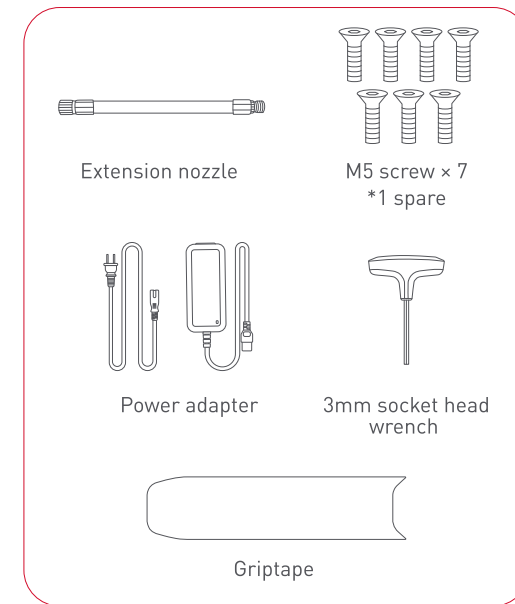
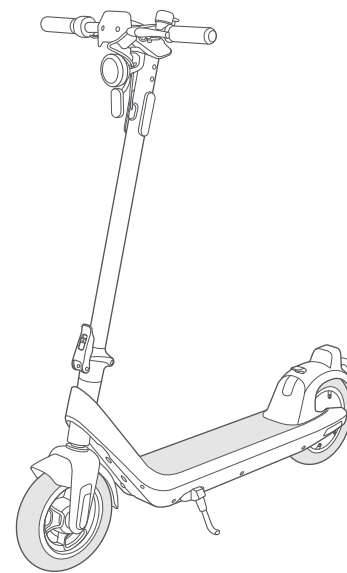

## Parts Info

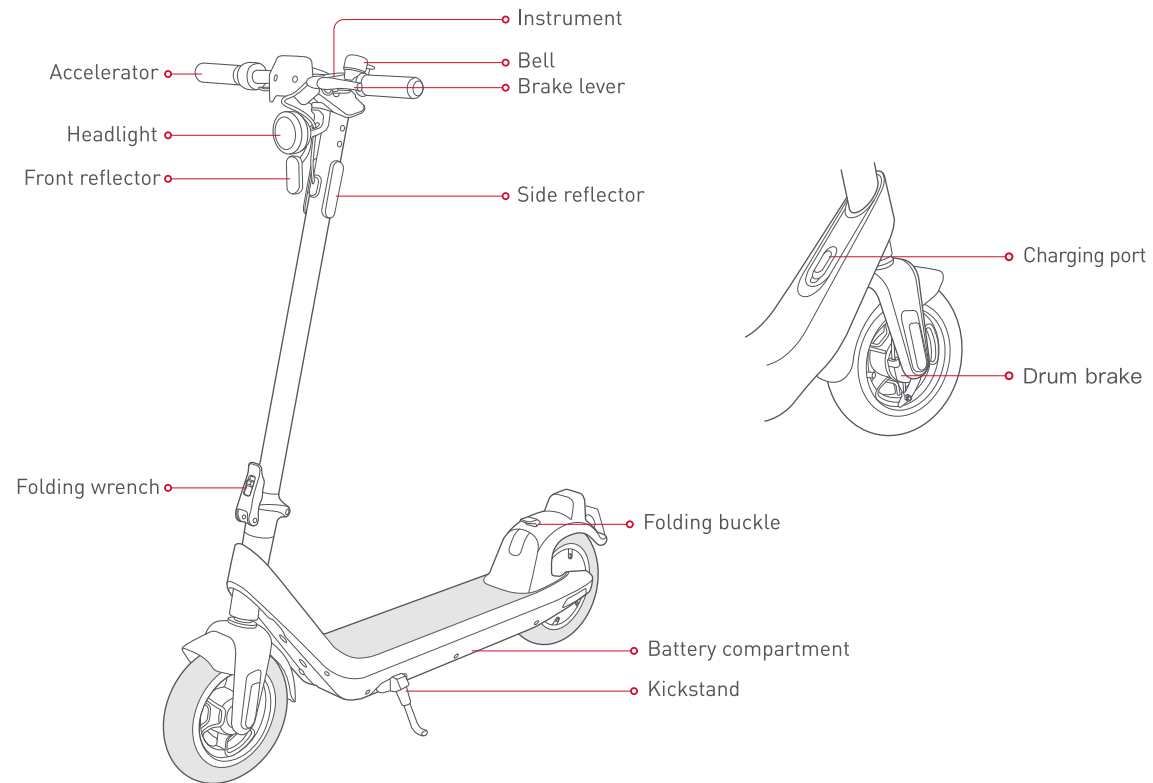

## Dashboard Info

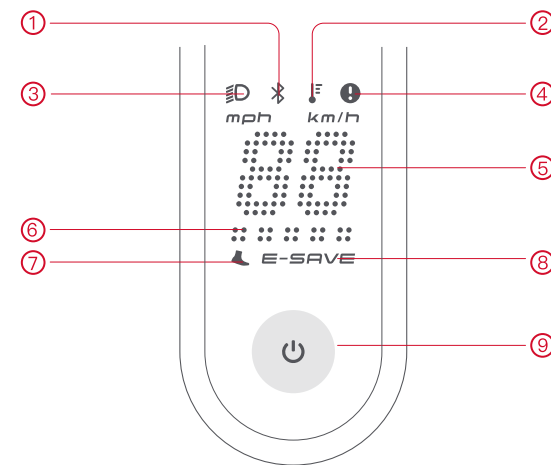

① Bluetooth status

④ Fault warning

⑦ Pedestrian mode status

Short press \*5 to get into the pedestrian mode, the speed will be limited to 6KM/H, Short press the button to exit this mode

② Abnormal temperature warning

⑤ Real-time vehicle speed/ fault code display

⑧ Riding mode

E-SAVE lights up: Eco mode  
E-SAVE goes out: Sport mode  
E-SAVE flashes: Custom mode (in-App).

③ Light status

⑥ Battery indicator

⑨ Operation keys

Long press the power button to turn on or off the device  
Short press \*1 for mode switch  
Short press \*2 for light switch,  
Short press \*3 for speed unit switch  
Short press \*5 to get into the pedestrian mode

# Installation Guide

## Body assembly

**01** Secure the scooter neck tube and open the kickstand.

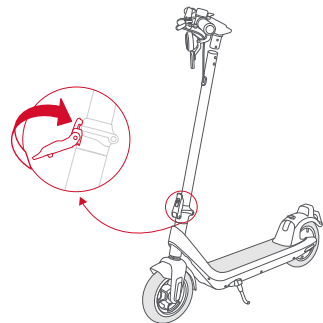

**02** Connect the handlebar to the main line connector of the vertical tube, and install the handlebar to the vertical tube.

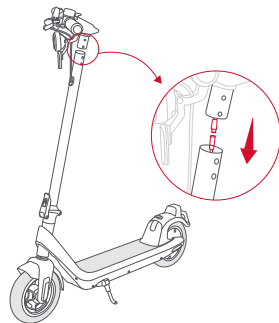

**03** Confirm that the device will power on and off after assembly.

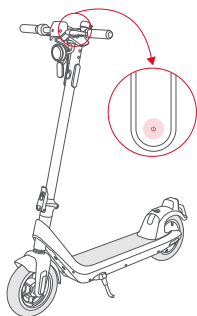

**04** Lock the screws on both sides alternately with the hexagon wrench in the packaging box (tightening torque: 4~5N\*m), that is, the assembly is completed.

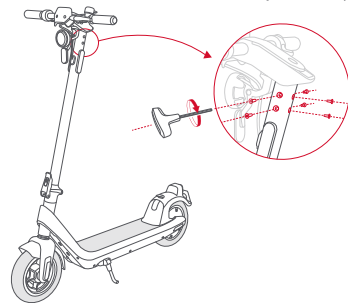

## Folding and handling

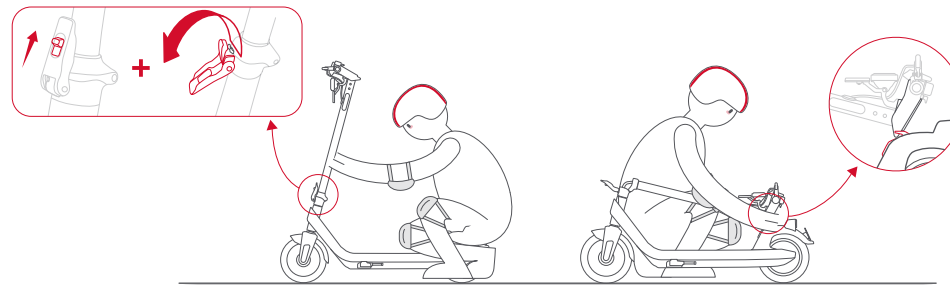

## Folding

Confirm that the kick scooter is powered off, then hold the vertical tube, open the folding wrench, align it to the position of the mudguard hook, and finally hook the hook under the dashboard to the rear end of the body. Press the buckle button on the mudguard when opening. After the hook under the dashboard is separated from the folding buckle, straighten the vertical tube to lock the folded plate and then turn the folding wrench back.

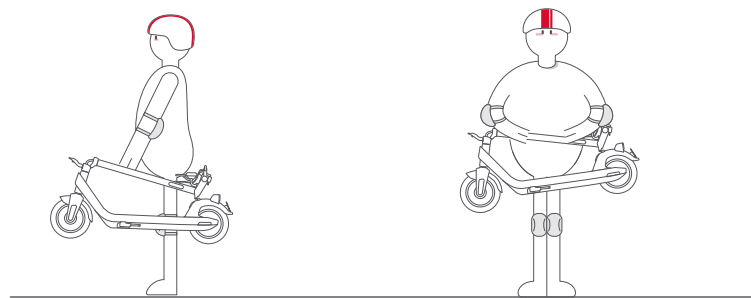

## Handling

Fold and then hold the standpipe with one hand or both hands before transport.

## Parking instructions

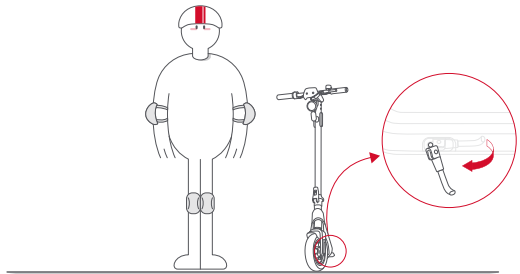

Please lower the kickstand after using and park the vehicle. Please raise the kickstand before using.

## Charger connection

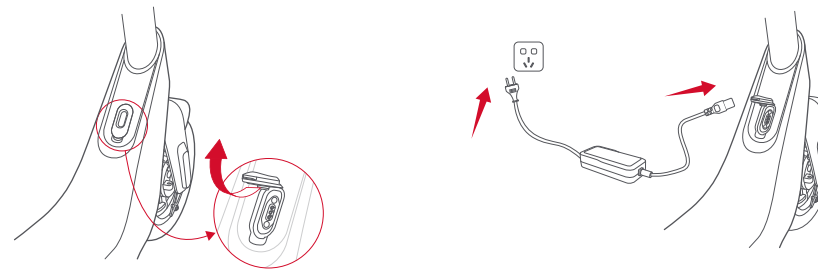

Firstly open the charging port, then plug the charging plug into the body charging port and finally connect the power supply to charge. After the completion of charging, fastening down the charging port to beware of water intake.

### **⚠ CAUTION**

- Do not charge when the charging port, charger or power socket is wet.
- Turn off the power before charging.
- Use only the original charger supplied by NIU for charging.
- Do not charge or continue using the battery if the battery is damaged or flooded.
- Close the rubber cover after charging or when not charging.
- Do not charge outdoors.
- Do not ride while charging.

## Fast locking

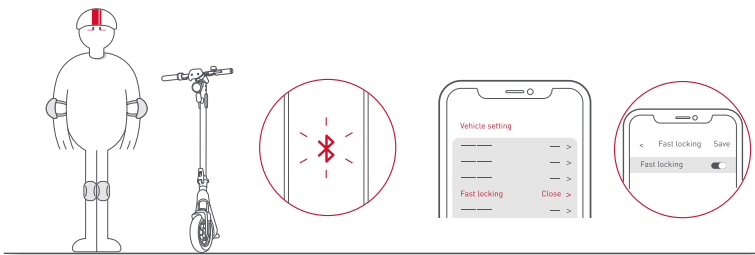

### Lock

**01**

Connect your electric scooter to the installed App of Niu Technologies via Bluetooth, and activate the fast locking function in the App.

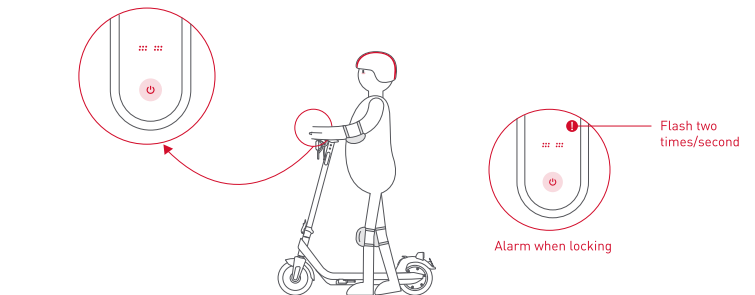

**02**

Long press the On/Off button for 5s to lock your scooter, with the lock icon displayed on the meter.

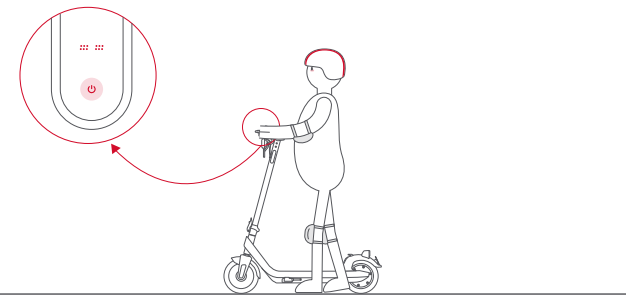

### Unlock

**01**

Long press the On/Off button for 2s to start your scooter.

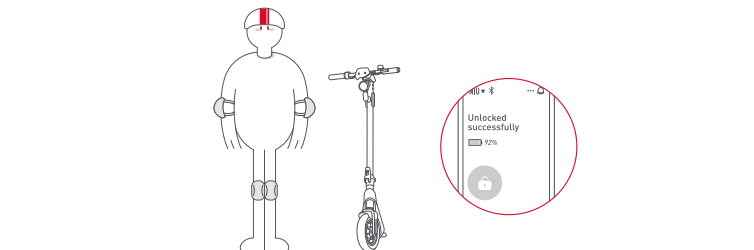

**02**

Click the Unlock button on the App interface to unlock your scooter connected to the App.

# Downloading the App



NIU E-Scooter App

Scan the QR code on the left, install the Niu E-scooter App, bind and activate the scooter according to the prompts.

Safety risks are present when using the scooter. You must complete the teaching guide for newbies through the App before initial use. For your safety, the new scooter is inactive and will be locked in the E-save position until you complete all the teaching contents for newbies. You need to install the Niu Technologies App on your mobile device, connect it to your kick scooter via Bluetooth, complete the activation and binding according to the prompts in App, and learn the contents for newbies. You can enjoy all the functions of the kick scooter after all these contents are completed.

Your mobile phone needs to be the Bluetooth functional version 4.2 or above; iOS system version 9.0 or above; Android™ system version Android 5.0 or above.

**PLEASE NOTE - NEW USER MODE:** After watching the tutorial video, during the 500m ride, the scooter will be locked in E-SAVE mode.

This function is intended for first time use only to ensure user safety and allow time for users to conform to a new driving experience.

After 500m, the scooter will beep to let you know that you can now change modes and more features will be available in the app.

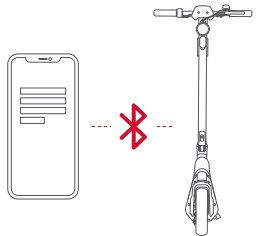

**01** After installing the App, please log in and register.

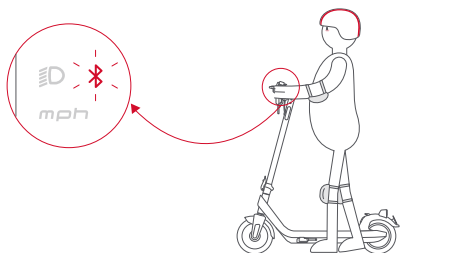

**02** Long press the button to power it up and the Bluetooth icon will start flashing.

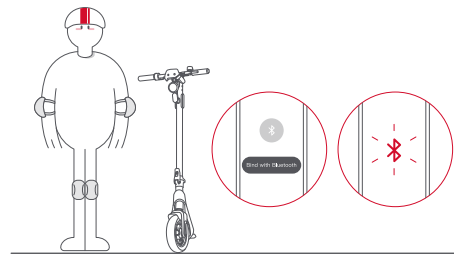

**03** Click [Me], [Device Binding] and [Bind with Bluetooth] to connect to your scooter. The scooter beeps, indicating that the Bluetooth is connected successfully. The icon will stop flashing and keep on once the connection is successful.

\* The device paired by Bluetooth with the vehicle for the first time is the vehicle's owner. If the device is changed, you need to remake the pairing.

\* If you change NIU account, the original account owner should unbind the vehicle from his account first.

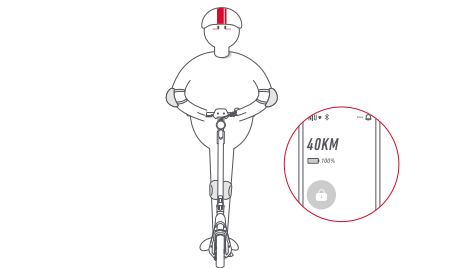

**04** Activate the scooter according to the prompts of App and learn how to drive safely. Now you can get your scooter started, check the status of your scooter and interact with other riders through the App. Enjoy yourself!



# ARE YOU READY?

## Precautions before riding:

- Ensure that the steering system and folding system are working properly, and the components are tightly secured.
- Check whether the wheel axle is fastened to the body to ensure that the wheel can rotate normally and the brake system can work normally.
- Please check the tire pressure before riding. It is recommended that the tire pressure be between 45-50psi.
- Check the wear of the tires and brake pads. If the wear is serious and need to be replaced, please contact the qualified people in time.

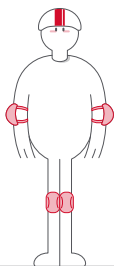

 The risk of fall injuries is present during practice, so please wear helmet, elbow pads, knee pads and wrist guards while riding.

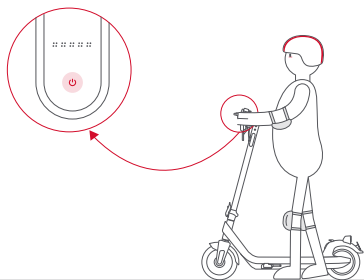

**01** Turn on the power and check the power indicator.

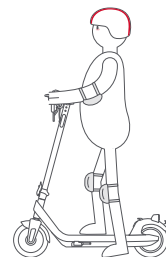

**02** Stand on the pedal with one foot and push back with the other foot.

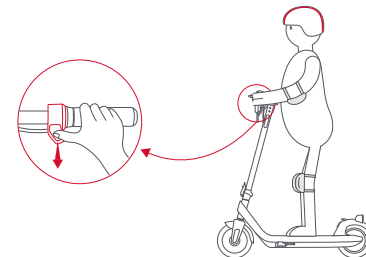

**03** When the kick scooter is sliding, stand on the pedal with the other foot, keep both feet stable, while gently pressing the throttle twistgrip. (The speed above 4km/h will start the throttle)

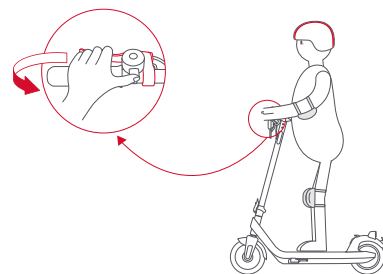

**04** Release the throttle twistgrip and use the energy recovery to achieve the effect of deceleration. Emergency braking requires powerful grip on the brake lever.

\* The deceleration can be adjusted through energy recovery within the App.

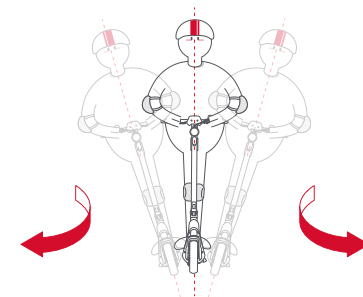

**05** The body should lean slightly to the direction of turning, and slowly turn the handlebar during a turn.

# Warnings

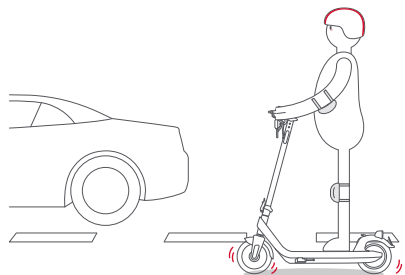

⊗ It is forbidden to drive into public roads, motorways or highways.



⊗ Please avoid riding in the rain. Braking distance will be extended in wet weather, so drive carefully.



⊗ It is forbidden to drive if water level exceeds 2cm.

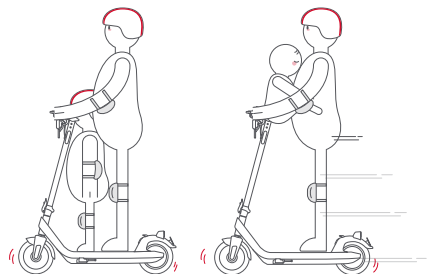

⊗ It is forbidden for multiple people to drive a scooter or to drive with children in arms.

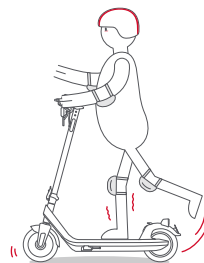

⊗ Do not ride with one foot on the pedal or on the ground. Please always wear shoes.

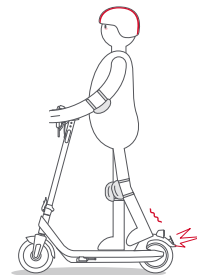

⊗ It is forbidden to step on the back of the mudguard.

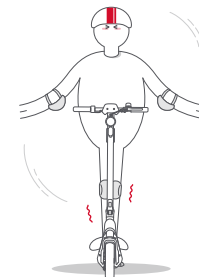

⊗ Always keep your hands on the handlebar when driving.

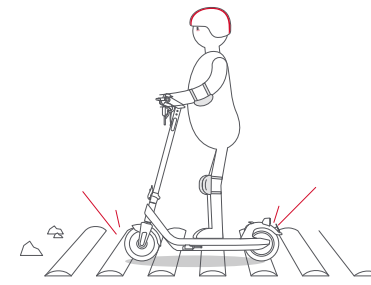

⚠ Do not pass at high speed when encountering deceleration zone / potholes or other unconventional roads pavement.

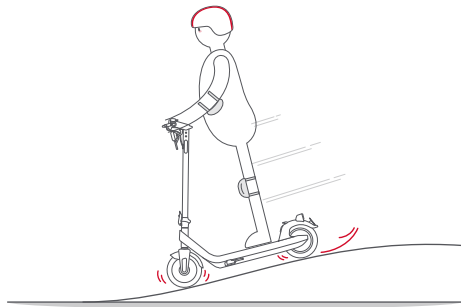

 Do not accelerate downhill.

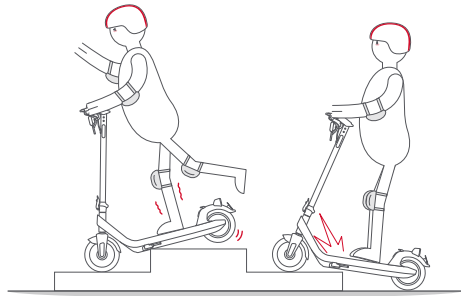

 It is forbidden to ride up and down stairs on kick scooters as well as jumping obstacles.

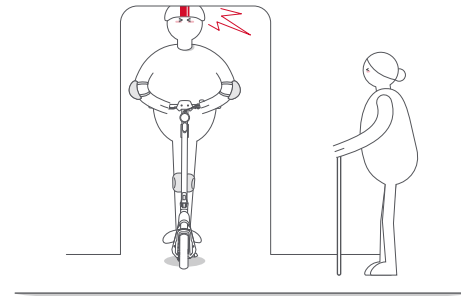

 Do not drive indoors.

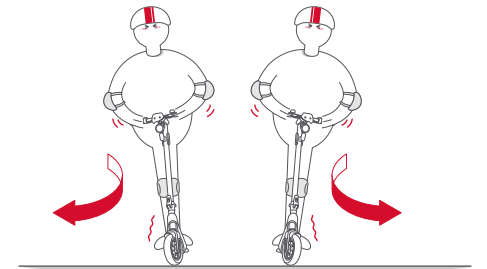

 It is forbidden to turn the handle substantially at high speed.

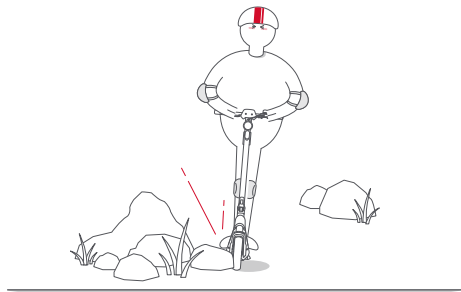

 Please avoid obstacles. Turn on the vehicle headlight when driving in the dark.



 Do not hang heavy objects such as backpack on the handlebar as the stability of the vehicle can be affected.



 Do not twist the throttle when walking with the kick scooter.

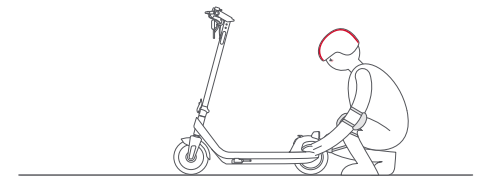

 Do not touch the disc brake in a short time after use to avoid burns.

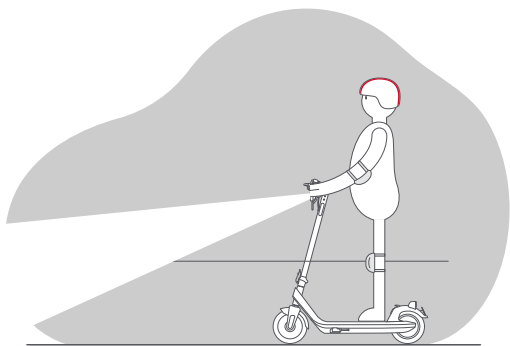

 Advice not to ride in the darkness.

## WARNING

- WARNING! As with any mechanical component, a vehicle is subject to high stresses and wear. The various materials and components may react differently to wear or fatigue. If the expected service life for a component has been exceeded, it may break suddenly, therefore risking causing injuries to the user. Cracks, scratches and discoloration in the areas subject to high stresses indicate that the component has exceeded its service life and should be replaced.
- Traffic conditions in the city has many obstacles to cross such as curbs or steps. It is recommended to avoid obstacle jumps. It is important to anticipate and adapt your trajectory and speed to those of a pedestrian before crossing these obstacles. It is also recommended to get out of the vehicle when these obstacles become dangerous due to their shape, height or slippage.

- WARNING! Keep plastic covering away from children to avoid suffocation.
- Get closer to your seller so he can refer you to an Appropriate training organization.
- Avoid high traffic or overcrowded areas.
- In any case, anticipate your trajectory and your speed while respecting the traffic rules, sidewalks and the most vulnerable, the pedestrians.
- Notify your presence when Approaching a pedestrian or cyclist.
- Walk while crossing the protected passages.
- In all cases, take care of yourself and others.
- Do not divert the use of the vehicle.
- This vehicle is not intended for acrobatic use.
- Caution, the brake may become hot in use. Do not touch after use.

## WARNING

- Handle with care, be careful of possible sharp edges caused by use.
- Do not modify or transform the vehicle, including the steering tube and sleeve, stem, folding mechanism and rear brake.
- The self-hold nut as well as other self-hold parts may lose. These parts need to be checked regularly.
- Do not make any modifications that are not noted in the instructions.

# Troubleshooting

## Troubleshooting of the whole vehicle

Malfunction Description	Causes	Troubleshooting
31 displayed	Battery MOS tube damaged	Please contact the dealer
32 displayed	Battery moistened by water	
37 displayed	Battery short-circuit protection warning	
33 displayed	Battery open-circuit or imbalance warning	
34 displayed	Batter low-temperature warning	Place the vehicle at room temperature and reuse it after the temperature is recovered
35 displayed	Batter over-temperature warning	Please make the vehicle still and use it after the internal temperature of the vehicle is normal
38 displayed	Battery charging overcurrent protection warning	Please disconnect the charger
39 displayed	Battery discharging overcurrent protection warning	Please contact the dealer
40 displayed	Battery over-charging warning	You can ride normally, and it can recover after electricity reduces
41 displayed	Battery over-discharging warning	Please charge the vehicle
42 displayed	Battery communication fault and verification failure	Limit speed to 6km/h, please contact the dealer

Malfunction Description	Causes	Troubleshooting
01 displayed	Power tube fault of the controller	Please contact the dealer
02 displayed	Brake fault	Please check the state of accelerator switch or contact the dealer
03 displayed	Accelerator fault	Please check the state of brake handle or contact the dealer
04 displayed	Controller overcurrent	Please contact the dealer
05 displayed	Controller over-temperature	Please make the vehicle still and use it after the internal temperature of the vehicle is normal
06 displayed	Fault of driving power of the controller	Please contact the dealer
08 displayed	Undervoltage/overvoltage of the controller	Please charge the vehicle or contact the dealer
07 displayed	Controller communication fault and verification failure	Please contact the dealer
10 displayed	Motor locked-rotor	
11 displayed	Motor phase loss	
12 displayed	Motor HALL fault	
13 displayed	Motor over-temperature	Please make the vehicle still and use it after the internal temperature of the vehicle is normal

# Maintenance and Care

## Vehicle cleaning

Wipe the main frame with a soft wet cloth. If buildup is formed and is hard to be cleaned, you can Apply toothpaste and rub with a toothbrush repeatedly, and then remove residue with a soft wet cloth.



Do not clean your scooter with alcohol, gasoline, kerosene or other corrosive and volatile solvents. These substances may damage the Appearance and internal structure of the vehicle body. Do not spray the scooter with pressure water guns or water pipes. Before cleaning, make sure that the scooter is in shut-down state, non-charging state, and the charging port has been buckled tightly, otherwise damage may be caused to electric parts by water leaking.

## Vehicle storage method

- Accessories and any additional items which are not Approved by the manufacturer shall not be used.
- Please store the vehicle in a flat, stable, well-ventilated and dry place.
- Prolonged exposure to UV rays, rain and the elements may damage the enclosure materials, store indoors when not in use.
- For a long storage period, keep the battery power between 30%-70% and recharge it every two months to extend the battery life.
- After long-term storage, please fully charge the battery before use and check the tire pressure.
- Do not charge when the charging port or charging cable is wet.
- If any abnormal sound and noise are caused during riding or pushing, do not ride. Carefully check the source of the abnormal sound and noise before riding again.
- If you notice a problem with the battery packs, do not change it yourself, contact our customer service.
- This device contains batteries which can only be replaced by qualified persons.

- Please only use the charger with this reference: (<PLD70-EVCN88-54>), otherwise the battery will be damaged or in danger of ignition or explosion.
- Do not touch the battery contacts, and do not open or expose the shell. Avoid short circuit caused by metal objects contacting the battery contact, otherwise battery damage or personal casualty may be caused.
- Do not store the vehicle near a heat source, otherwise it may cause battery failure, overheating, and even fire risk; If the battery is damaged or water enters the battery compartment, it is prohibited to charge or continue using the battery.

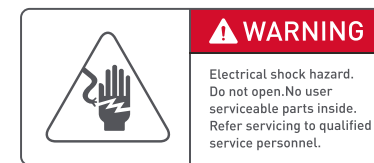

- It is strictly forbidden to immerse the battery and the vehicle body in water or ride in the rain, as well as cleaning the vehicle body with high-pressure water pipes in order to prevent water entering the battery compartment, circuit chip, etc.
- Do not take the battery out. The operation of the vehicle body may be affected due to wrong disassembly.
- Please check your tire status each time before you use the scooter and inflate them regularly. If the tire is cut or has irregular cracks, please ask a professional to replace them.

## Bearing maintenance

Check machine's status regularly. If you hear any abnormal bearing sounds, feel any abnormal vibrations or any other abnormal things (especially about machine's bearings), please stop using the scooter at once and ask a professional to check and repair. Do not try to repair yourself. Do not touch the disc brake.

## Durm brake debugging

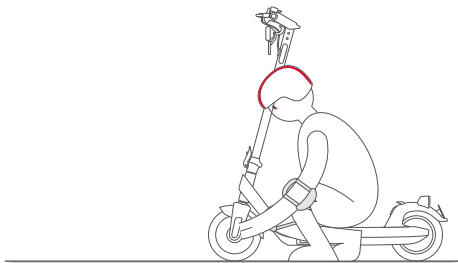

- Excessive braking force

If you feel that the brake is too tight, use a wrench to loosen the brake swing arm nut counterclockwise, return the brake cable to shorten the length of the exposed tail, lock the nut clockwise, confirm the brake force, complete the adjustment.

- Insufficient braking force

If the brake feels too loose, loosen the brake swing arm nut counterclockwise with a wrench, pull out the brake line to make its tail length slightly longer, lock the nut clockwise, and then brake to confirm the brake force, complete the adjustment.

## Handlebar shaking debugging

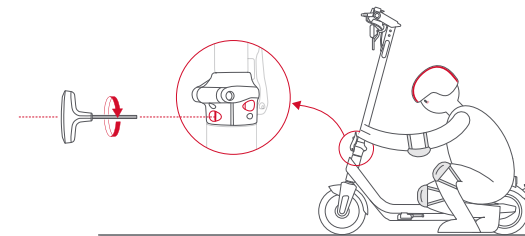

Check whether the vertical tube screws are loose. If so, fasten the standpipe screws first, and then fasten the two screws of the folding mechanism with a 6mm hexagon wrench.

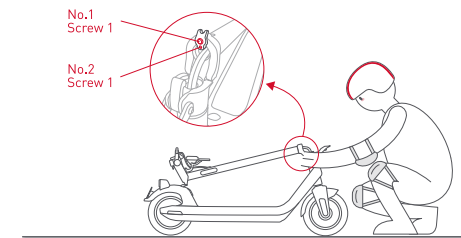

If the vertical tube wobbles due to falls, adjust No.1 screw and No.2 screw to modify.

- Loosen (counterclockwise) No.1 screw 3 to 4 turns using no.5 inner hexagon wrench;
- Tighten (clockwise) No.2 screw 2 to 3 turns using a no.2.5 inner hexagon wrench;
- Tighten (clockwise) No.1 screw using a no.5 inner hexagon wrench.

*\*If the above solution cannot be solved, please contact qualified people*

## Replacing mat

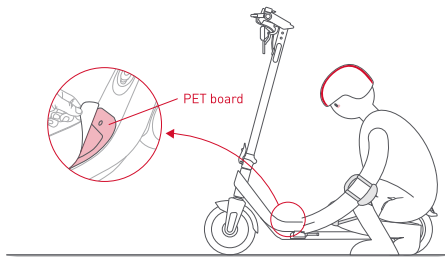

When replacing the mat, please directly remove the surface sandpaper for replacement. Do not remove the PET board below the sandpaper.

## Use of the extension nozzle

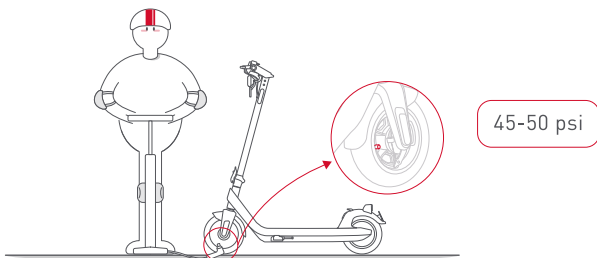

If your kick scooter front and rear tires are underinflated, please use the extension nozzle to connect the car body tires to inflate. First remove the front and rear tire inflatable nozzle cap, and then tighten the extended inflatable nozzle and tire inflatable nozzle, and connect the pump to inflate after they are to be tightened.

28

## Specifications

		KQi2 Pro
Product size	Before folding: Length × width × height	1147 × 520 × 1220 mm (45.1 × 20.5 × 48 in)
	After folding: Length × width × height	1147 × 520 × 520 mm (45.1 × 20.5 × 20.5 in)
Product weight	Net weight	Approx. 18.4 kg (40.6 lbs)
Riding request	Maximun Load	220 lbs (100 kg)
	Age range	14+ years old
	Height	3'11"~6'6" (120-200 cm)
Vehicle parameters	Maximum vehicle speed	Approx. 25 km/h (15.5 mph)
	Average battery life <sup>[1]</sup>	Approx. 40 km (24.9 miles)
	Maximum slope <sup>[2]</sup>	15%
	Applicable terrain	Flat pavement road, steps not higher than 0.4in (1cm), and road gap not exceeding 1.2in (3cm)
	Working temperature	14~113°F (-10~45°C)
	Storage temperature	32~104°F (0~40°C)
	A-weighted emission sound pressure level	50dB
	IP rating	IP54



		KQi2 Pro
Battery pack parameters	Rated voltage	46.8 VDC
	Rated voltage	365 Wh
	Charging voltage	54.6 VDC
	Charging temperature	32~113°F (0~45°C)
	Battery management system	7th NIU Energy™ smart power tech
Motor parameters	Rated power	0.3 kW
Tire parameters	Tire technical specifications	10" × 2.3"
	Recommended tire pressure	45-50 psi
Charger parameters	Input voltage	100-240 V ~ 1.5 A 50-60 Hz
	Rated output	53.5 V = 1.3 A
	Output power	70 W
	Charging time	Approx. 7h

[1] Average battery life: It is tested when the driver weighting 165lbs(75kg) drives at a constant speed of 9.3mph(15km/h) on a flat road in the ambient temperature of 77°F (25°C) in case of a full battery. (Factors affecting battery life include speed, number of startups and shutdowns, kinetic energy recovery setting, driver weight, ambient temperature.)

[2] Maximum Slope: The maximum gradient that driver weighting 165lbs(75kg) gets through at a constant speed of 5mph (8km/h) in the ambient temperature of 77°F (25°C) in case of a full battery.

## Maintenance Record

Date		Mileage	
<b>Notes:</b>			
<b>Dealer:</b>			

## Maintenance Record

Date		Mileage	
<b>Notes:</b>			
<b>Dealer:</b>			

## Maintenance Record

Date		Mileage	
<b>Notes:</b>			
<b>Dealer:</b>			